

Kit terminali manubrio - 97380951AA (Nero) - 97380951AB (Rosso)

Kit adattatori terminali manubrio - 97380961A

Handlebar end cap kit - 97380951AA (Black) - 97380951AB (Red)

Handlebar end cap adapter kit - 97380961A

Simbologia

Per una lettura rapida e razionale sono stati impiegati simboli che evidenziano situazioni di massima attenzione, consigli pratici o semplici informazioni. Prestare molta attenzione al significato dei simboli, in quanto la loro funzione è quella di non dovere ripetere concetti tecnici o avvertenze di sicurezza. Sono da considerare, quindi, dei veri e propri "promemoria". Consultare questa pagina ogni volta che sorgessero dubbi sul loro significato.



Attenzione

La non osservanza delle istruzioni riportate può creare una situazione di pericolo e causare gravi lesioni personali e anche la morte.



Importante

Indica la possibilità di arrecare danno al veicolo e/o ai suoi componenti se le istruzioni riportate non vengono eseguite.



Note

Fornisce utili informazioni sull'operazione in corso.

Riferimenti

I particolari evidenziati in grigio e riferimento numerico (Es. ①) rappresentano l'accessorio da installare e gli eventuali componenti di montaggio forniti a kit.

I particolari con riferimento alfabetico (Es. Ⓐ) rappresentano i componenti originali presenti sul motoveicolo.

Tutte le indicazioni destro o sinistro si riferiscono al senso di marcia del motociclo.

Avvertenze generali



Attenzione

Le operazioni riportate nelle pagine seguenti devono essere eseguite da un tecnico specializzato o da un'officina autorizzata Ducati.



Attenzione

Le operazioni riportate nelle pagine seguenti se non eseguite a regola d'arte possono pregiudicare la sicurezza del pilota.



Note

Documentazione necessaria per eseguire il montaggio del Kit è il Manuale Officina, relativo al modello di moto in vostro possesso.



Note

Nel caso fosse necessaria la sostituzione di un componente del kit consultare la tavola ricambi allegata.

Symbols

To allow quick and easy consultation, this manual uses graphic symbols to highlight situations in which maximum care is required, as well as practical advice or information. Pay attention to the meaning of the symbols since they serve to avoid repeating technical concepts or safety warnings throughout the text. The symbols should therefore be seen as real reminders. Please refer to this page whenever in doubt as to their meaning.



Warning

Failure to follow these instructions might give rise to a dangerous situation and provoke severe personal injuries or even death.



Caution

Failure to follow these instructions might cause damages to the vehicle and/or its components.



Notes

Useful information on the procedure being described.

References

Parts highlighted in grey and with a numeric reference (Example ①) are the accessory to be installed and any assembly components supplied with the kit.

Parts with an alphabetic reference (Example Ⓐ) are the original components fitted on the vehicle.

Any right- or left-hand indication refers to the vehicle direction of travel.

General notes



Warning

Carefully perform the operations on the following pages since they might negatively affect rider safety.



Warning

Carefully perform the operations on the following pages since they might negatively affect rider safety.



Notes

The following documents are necessary for assembling the Kit: Workshop Manual of your bike model.



Notes

Should it be necessary to change any kit parts, please refer to the attached spare part table.



Warning

Operating, servicing and maintaining a passenger vehicle or off-highway motor vehicle can expose you to chemicals including engine exhaust, carbon monoxide, phthalates, and lead, which are known to the State of California to cause cancer and birth defects or other reproductive harm. To minimize exposure, avoid breathing exhaust, do not idle the engine except as necessary, service your vehicle in a well-ventilated area and wear gloves or wash your hands frequently when servicing your vehicle. For more information go to www.P65Warnings.ca.gov/passenger-vehicle.

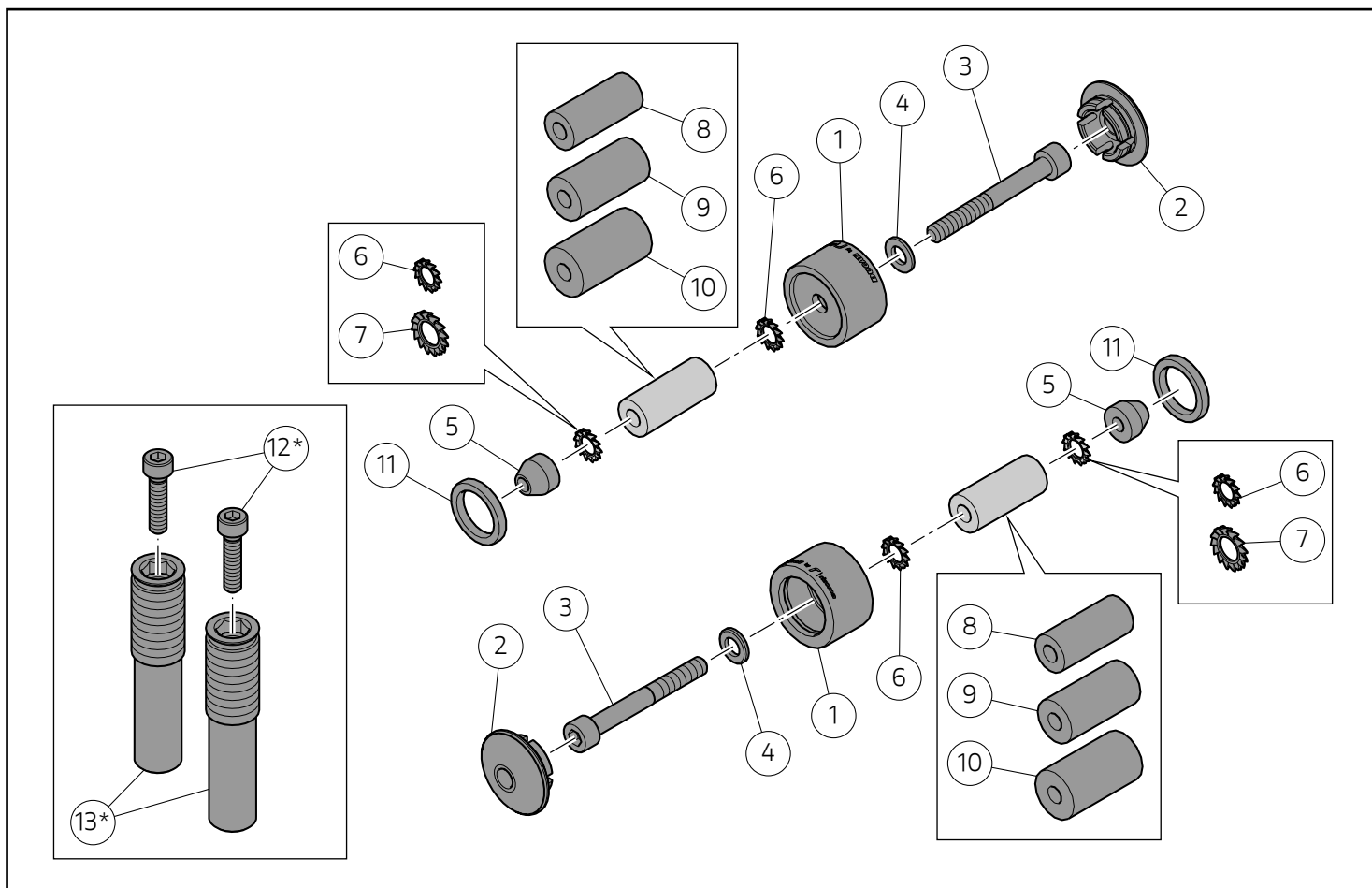

Importante

I componenti del kit possono essere soggetti ad aggiornamenti; consultare il DCS (Dealer Communication System) per avere informazioni sempre aggiornate.

Note

I particolari contraddistinti dal simbolo (*) compongono il kit adattatori terminali manubrio, il quale deve essere abbinato al kit terminali manubrio solo per i motoveicoli:

- Panigale 899; 959; 1199; 1299
- Panigale R

Important

The parts of the kit can be updated; for information always up to date, please refer to DCS (Dealer Communication System).

Notes

The parts indicated with the symbol (*) make up the handlebar end cap adapter kit, which must be matched with handlebar end cap kit only for the following motorcycles:

- Panigale 899; 959; 1199; 1299
- Panigale R

Pos.	Denominazione	Description
1	Terminale manubrio	Handlebar end cap
2	Tappo	Plug
3	Vite M6x70	Screw M6x70
4	Rosetta	Washer
5	Boccola	Bushing
6	Rosetta dentellata Ø 6	Toothed washer Ø 6
7	Rosetta dentellata Ø 8	Toothed washer Ø 8
8	Espansore Ø 13	Expander Ø 13
9	Espansore Ø 15	Expander Ø 15
10	Espansore Ø 17	Expander Ø 17
11	Distanziale	Spacer
12*	Vite TCEI M6x25	TCEI screw M6x25
13*	Perno filettato	Threaded pin

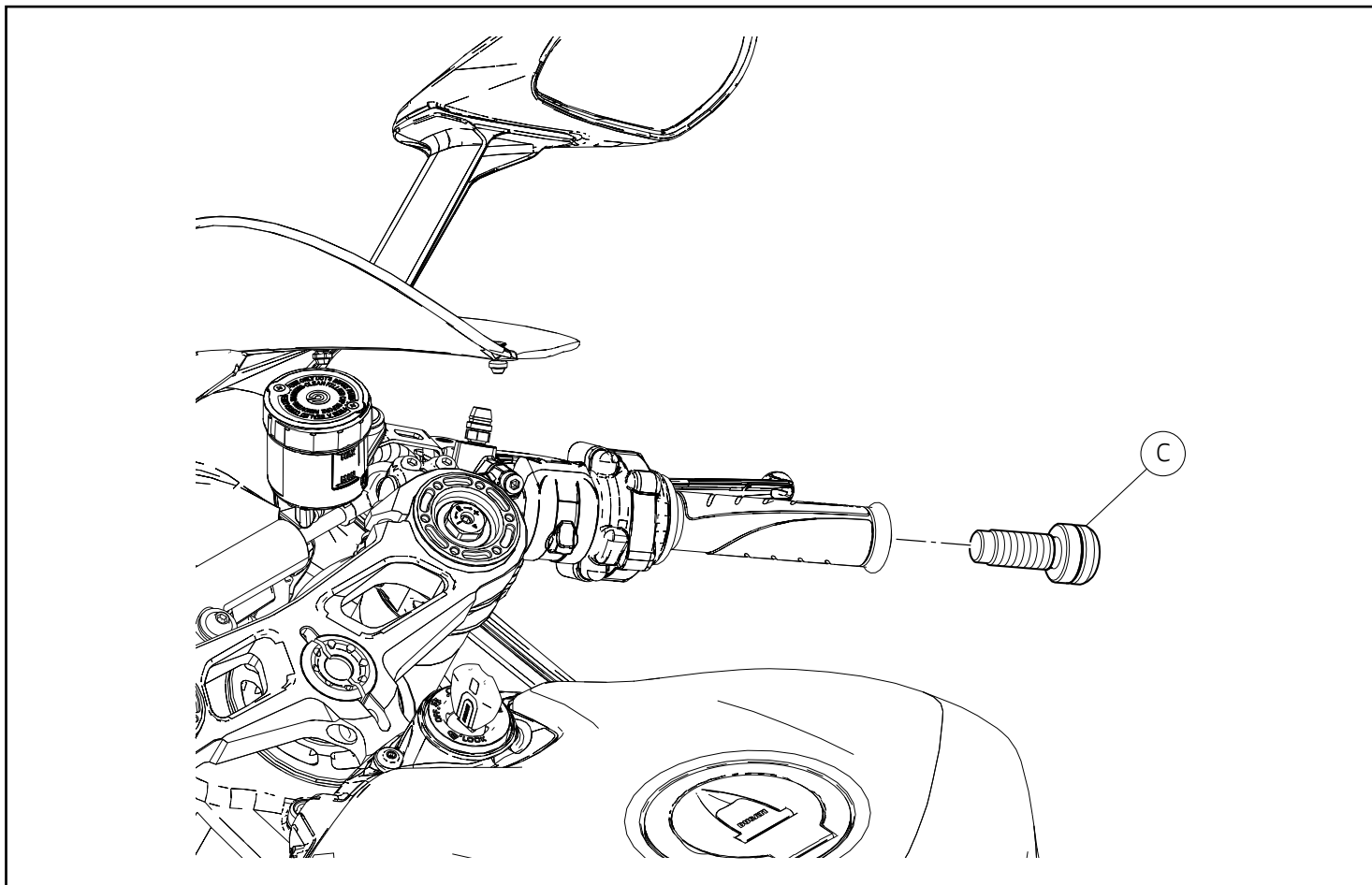

Smontaggio componenti originali



Note

La procedura di smontaggio dei componenti originali e montaggio dei componenti kit è la stessa per tutti i motoveicoli:

- Panigale 899; 959; 1199; 1299
- Panigale R



Note

La procedura di smontaggio dei componenti originali è la stessa per tutti i motoveicoli sopraelencati, per cui viene utilizzata come esempio, la procedura da adottare sul modello Panigale 1299.

Operando sul lato destro del motoveicolo, rimuovere il gruppo contrappeso destro (C).

Ripetere la stessa operazione per rimuovere il gruppo contrappeso sinistro.

Removing the original components



Notes

The procedure to remove original components and assembly kit components is the same for all motorcycles:

- Panigale 899; 959; 1199; 1299
- Panigale R



Notes

The original component removal procedure is the same for all the motorcycles listed above. The procedure for the Panigale 1299 model will be described here as a general example.

Working on RH side of the motorcycle, remove RH balancing weight assembly (C).

Repeat the same operation to remove LH balancing weight assembly.

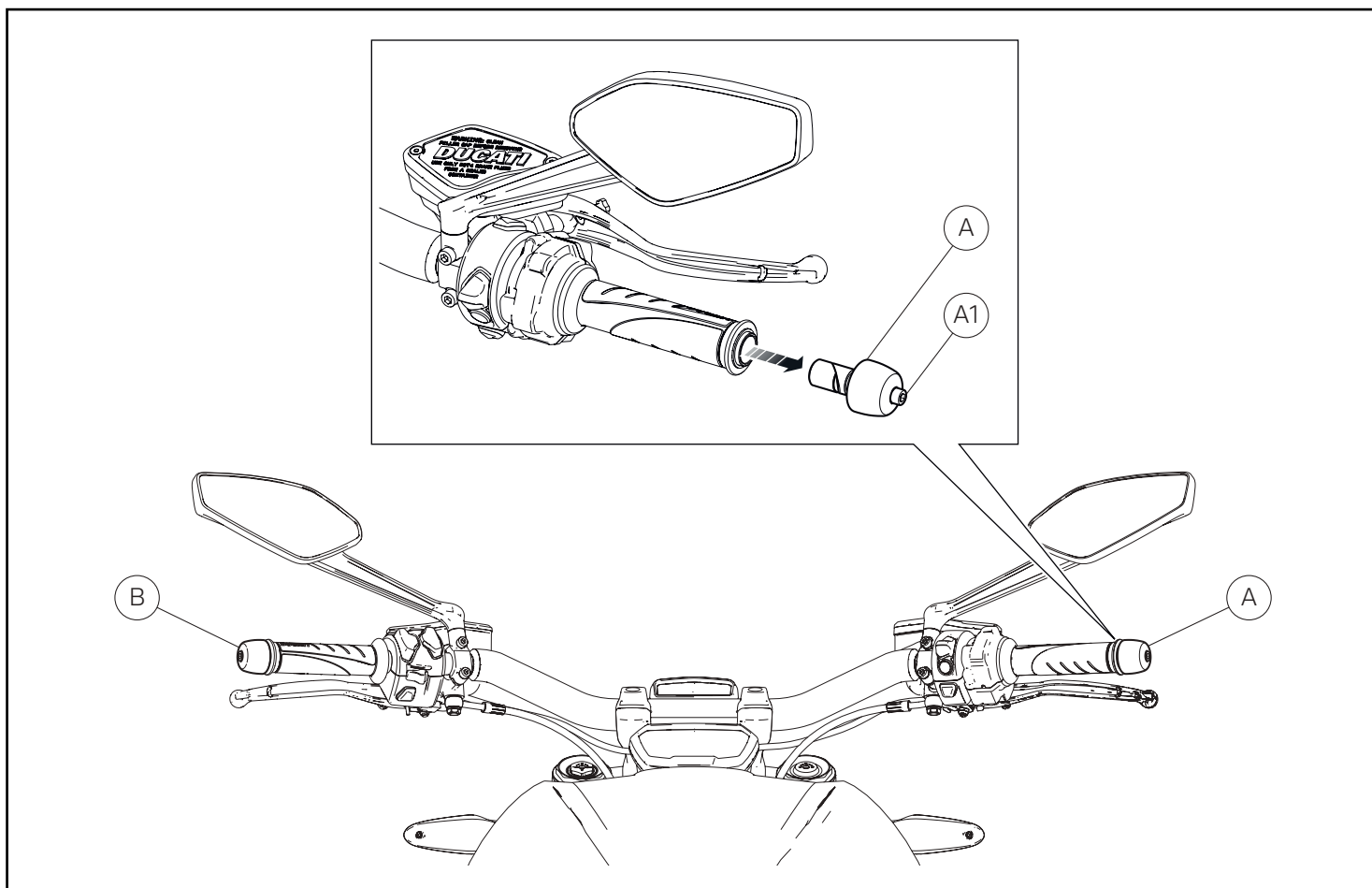

Note

La procedura di smontaggio dei componenti originali è la stessa per tutti i motoveicoli:

- Diavel
- Monster 659; 797; 821; 1200
- XDiavel
- Supersport

Note

La procedura di smontaggio dei componenti originali è la stessa per tutti i motoveicoli sopraelencati, per cui viene utilizzata come esempio, la procedura da adottare sul modello XDiavel.

Operando sul lato destro del motoveicolo, allentare prestando attenzione a non svitare completamente la vite (A1) e rimuovere il gruppo contrappeso destro (A).

Ripetere la stessa operazione per rimuovere il gruppo contrappeso sinistro (B).

Notes

The original component removal procedure is the same for all motorcycles:

- Diavel
- Monster 659; 797; 821; 1200
- XDiavel
- Supersport

Notes

The original component removal procedure is the same for all the motorcycles listed above. The procedure for the XDiavel model will be described here as a general example.

Working on motorcycle RH side, loosen screw (A1) paying attention not to unscrew it completely and remove RH balancing weight assembly (A).

Repeat the same procedure to remove LH balancing weight assembly (B).

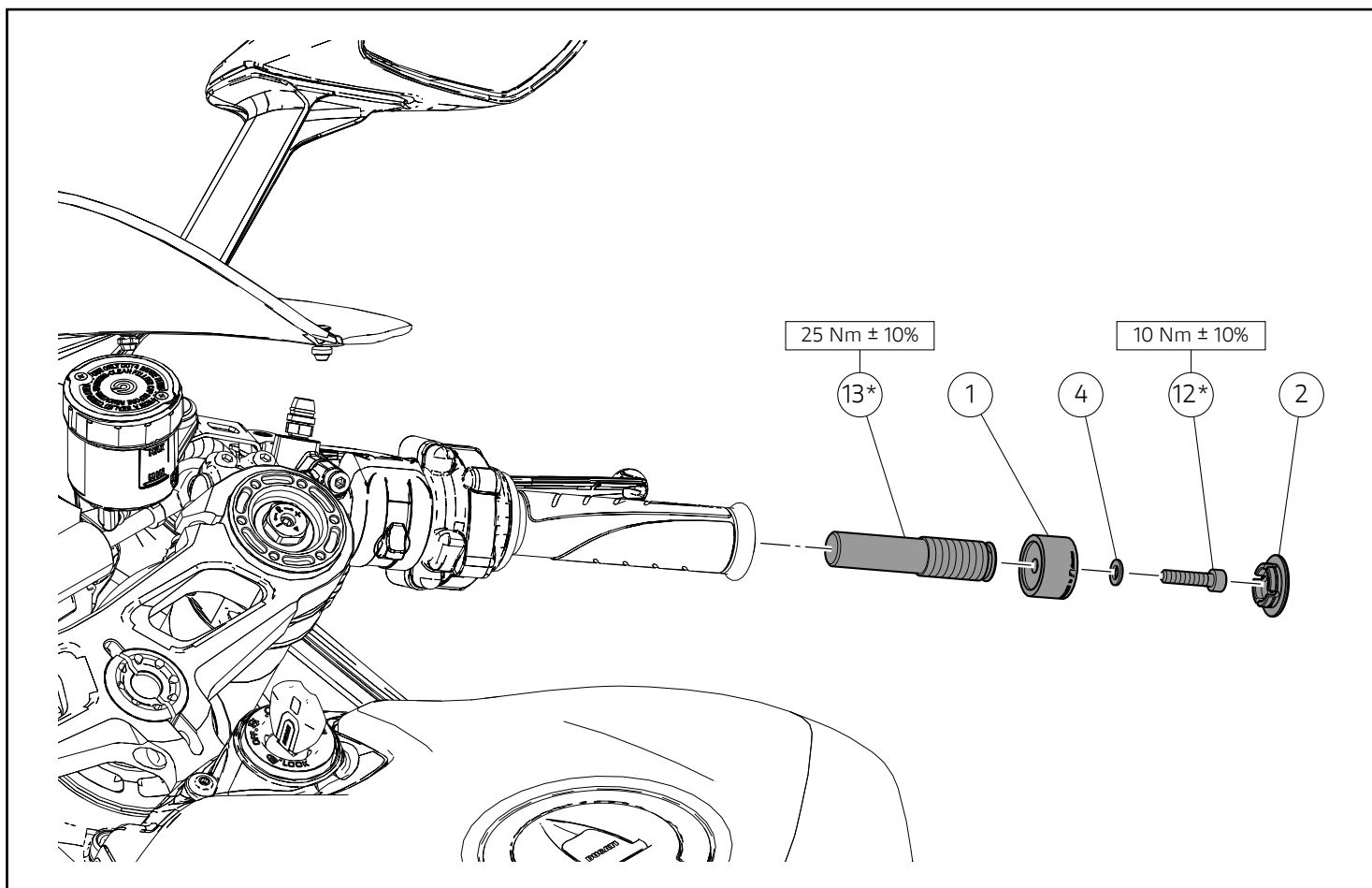

Montaggio componenti kit

● Importante

Verificare, prima del montaggio, che tutti i componenti risultino puliti e in perfetto stato. Adottare tutte le precauzioni necessarie per evitare di danneggiare qualsiasi parte nella quale ci si trova ad operare.

👁 Note

La procedura di montaggio dei componenti kit è la stessa per tutti i motoveicoli:

- Panigale 899; 959; 1199; 1299
- Panigale R

👁 Note

La procedura di montaggio dei componenti kit è la stessa per tutti i motoveicoli sopraelencati, per cui viene utilizzata come esempio, la procedura da adottare sul modello Panigale 1299.

Montaggio terminale manubrio

Applicare LOCTITE 222 sul filetto del perno (13*). Impuntare e serrare il perno (13*) sul semimanubrio, alla coppia indicata. Inserire la rosetta (4) sul filetto della vite (12*). Posizionare il terminale manubrio (1) sul semimanubrio e impuntare la vite (12*). Serrare la vite (12*), alla coppia indicata. Montare il tappo (2) sul terminale manubrio (1).

Ripetere la stessa operazione per il montaggio terminale manubrio sul lato sinistro del motoveicolo.

Assembling the kit components

● Important

Before assembling, check that all parts are clean and in good conditions. Adopt all necessary precautions to avoid damaging any part you are working on.

👁 Notes

The kit component assembly procedure is the same for all motor-cycles:

- Panigale 899; 959; 1199; 1299
- Panigale R

👁 Notes

The kit component assembly procedure is the same for all the motor-cycles listed above. The procedure for the Panigale 1299 model will be described here as a general example.

Handlebar end cap assembly

Apply LOCTITE 222 on the thread of pin (13*). Start and tighten pin (13*) on handlebar, to the specified torque. Insert washer (4) on screw (12*) thread. Position handlebar end cap (1) on handlebar and start screw (12*). Tighten screw (12*) to the specified torque. Fit plug (2) on handlebar end cap (1).

Repeat the same procedure to assembly the handlebar end cap on the motorcycle LH side.

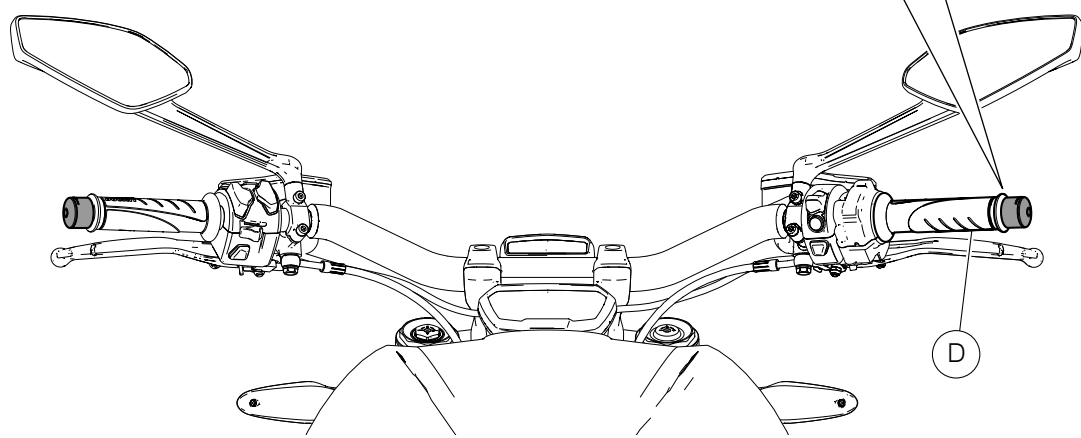
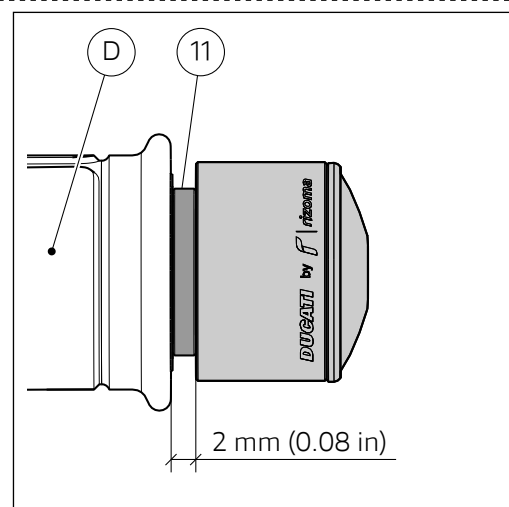
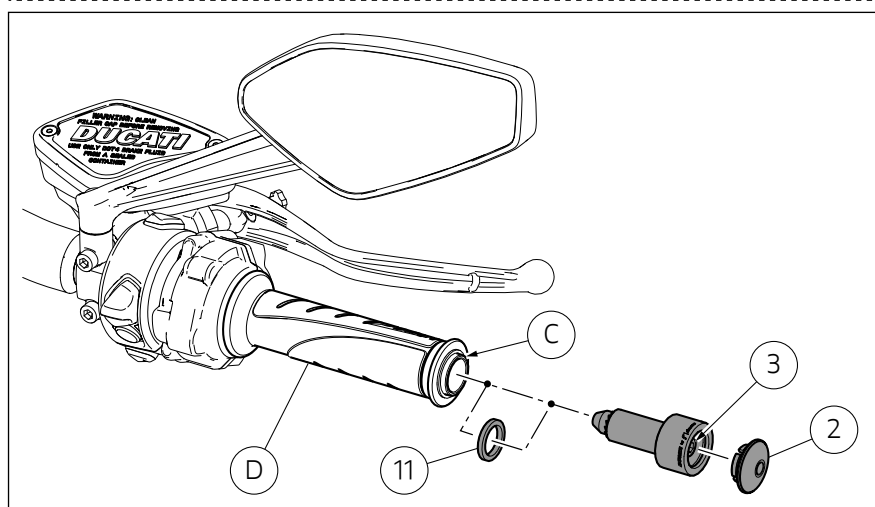
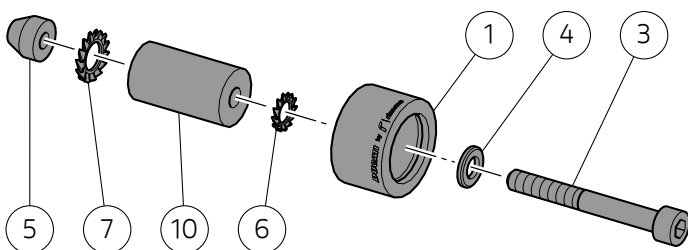
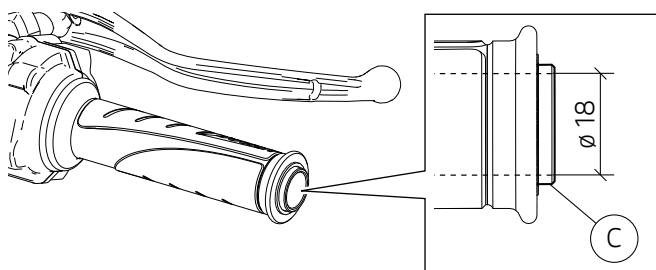
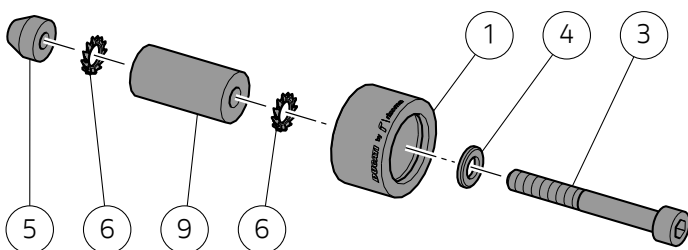
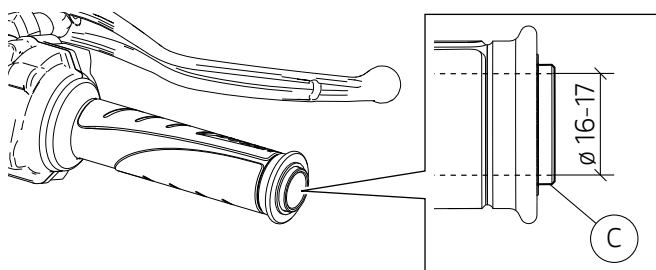
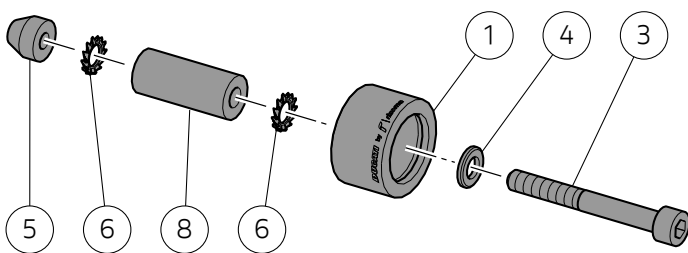
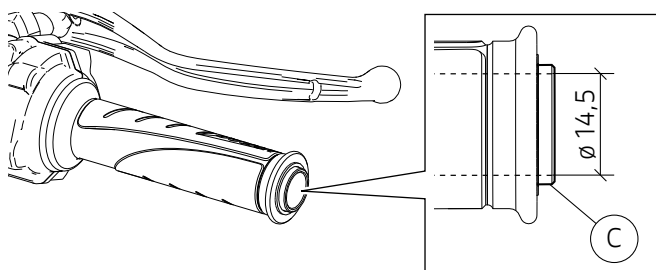

**Note**

La procedura di montaggio dei componenti kit è la stessa per tutti i motoveicoli:

- Diavel
- Monster 659; 797; 821; 1200
- XDiavel
- Supersport

**Note**

La procedura di smontaggio dei componenti originali è la stessa per tutti i motoveicoli sopraelencati, per cui viene utilizzata come esempio, la procedura da adottare sul modello XDiavel.

Premontaggio terminale manubrio

Inserire la rosetta (4) sul filetto della vite (3). Introdurre la vite (3) sul terminale manubrio (1). Dal lato opposto, sul filetto della vite (3), inserire la rosetta dentellata (6).

**Importante**

Gli espansori (8), (9), (10) e le rosette dentellate (6), (7) sono in alternativa tra loro, in base al diametro interno del manubrio (C).

Inserire l'espansore e la rosetta adeguata sul filetto della vite (3) e avvitare la boccola (5).

Montaggio terminale manubrio

Operando sul lato destro del motoveicolo, montare il gruppo terminale, fino a battuta, nel manubrio (C), verificando che la distanza tra il terminale del comando acceleratore (D) e il gruppo terminale manubrio non risulti inferiore a 2 mm (0.08 in).

**Attenzione**

Nel caso in cui la distanza risulti inferiore ai 2 mm (0.08 in), è necessario montare il distanziale (11).

**Attenzione**

A montaggio ultimato verificare che il comando acceleratore (D) ruoti liberamente su tutta la sua corsa.

Serrare la vite (3) sino al bloccaggio del gruppo terminale sul manubrio (C). Montare il tappo (2) sul gruppo terminale manubrio.

Ripetere la stessa operazione per il montaggio terminale manubrio sul lato sinistro del motoveicolo.

**Notes**

The kit component assembly procedure is the same for all motorcycles:

- Diavel
- Monster 659; 797; 821; 1200
- XDiavel
- Supersport

**Notes**

The original component removal procedure is the same for all the motorcycles listed above. The procedure for the XDiavel model will be described here as a general example.

Handlebar end cap pre-assembly

Insert washer (4) on screw (3) thread. Insert screw (3) on handlebar end cap (1). On the opposite side, fit toothed washer (6) on screw (3) thread.

**Important**

It is possible to alternate expanders (8), (9), (10) and toothed washers (6) and (7) according to the internal handlebar (C) diameter.

Fit the suitable expander and washer on screw (3) thread and tighten the bushing (5).

Handlebar end cap assembly

Working on motorcycle RH side, fit the end cap assembly on the handlebar (C) until it stops, checking that the distance between the throttle control end cap (D) and the handlebar end cap assembly is not less than 2 mm (0.08 in).

**Warning**

Should the distance be less than 2 mm (0.08 in), fit the spacer (11).

**Warning**

When the assembly is completed, check that the throttle control (D) turns freely along its whole stroke.

Tighten screw (3) until the end cap assembly is locked on the handlebar (C). Fit plug (2) on the handlebar end cap assembly.

Repeat the same procedure to assemble the handlebar end cap on the motorcycle LH side.

Kit embouts guidon - 97380951AA (Noir) - 97380951AB (Rouge)
 Kit adaptateurs embouts guidon - 97380961A
 Kit Lenkerabschlußstopfen - 97380951AA (Schwarz) - 97380951AB (Rot)
 Kit Adapter Lenkerabschlußstopfen - 97380961A

Symboles

Pour faciliter la consultation de ce manuel, des symboles signalent des situations exigeant le maximum d'attention, des conseils pratiques ou de simples informations. Lire attentivement la signification de ces symboles car ils renvoient à des concepts techniques ou des consignes de sécurité de la plus grande importance. Ils doivent être considérés comme de véritables « aide-mémoire ». Toujours consulter cette page en cas de doute concernant leur signification.



Attention

La non-observance des instructions reportées ci-dessous peut créer une situation dangereuse et provoquer de graves lésions personnelles voire la mort.



Important

Indique la possibilité d'endommager le véhicule et/ou ses composants si les instructions reportées ci-dessous ne sont pas suivies.



Remarques

Fournit des informations utiles sur l'opération en cours.

Références

Les pièces surlignées en gris et la référence numérique (Ex. ①) représentent l'accessoire à installer et les composants de montage éventuels fournis en kit.

Les pièces avec référence alphabétique (Ex. Ⓐ) représentent les composants d'origine présents sur le motorcycle.

Toutes les indications droite ou gauche se réfèrent au sens de marche la moto.

Avertissements généraux



Attention

Les opérations indiquées dans les pages suivantes, au cas où elles ne seraient pas effectuées selon les règles de l'art pourraient compromettre la sécurité du pilote.



Attention

Les opérations indiquées dans les pages suivantes, au cas où elles ne seraient pas effectuées selon les règles de l'art pourraient compromettre la sécurité du pilote.



Remarques

La documentation nécessaire pour effectuer la pose du Kit est le : Manuel D'atelier, relatif au modèle de moto en votre possession.



Remarques

Au cas où il serait nécessaire d'effectuer le remplacement d'un composant du kit, il faudra consulter la planche relative aux pièces détachées ci-jointe.

Symbole

Zum schnellen und übersichtlichen Lesen werden Symbole verwendet, die außerordentlich wichtige Situationen, praktische Ratschläge oder auch nur einfache Informationen hervorheben. Der Bedeutung dieser Symbole ist besondere Aufmerksamkeit zu schenken, da sich hierdurch das ständige Wiederholen von technischen Konzepten oder Sicherheitshinweisen erübrigt. Sie stellen daher regelrechte „Merker“ dar. Diese Seite ist immer dann zur Hand zu nehmen, wenn Zweifel über die Bedeutung eines Symbols bestehen sollten.



Achtung

Eine Nichtbeachtung der hier wiedergegebenen Anweisungen kann Gefahrensituationen schaffen und zu schweren Verletzungen und auch zum Tod führen.



Wichtig

Weist darauf hin, dass bei Nichteinhaltung der hier wiedergegebenen Anweisungen die Möglichkeit für Schäden am Fahrzeug und/oder seiner Komponenten besteht.



Hinweis

Übermittelt nützliche Informationen zum betreffenden Arbeitsingriff.

Bezugsangaben

Die grau gekennzeichneten Bestandteile mit numerischem Bezug (Bsp. ①) geben das zu installierende Bestandteil und die eventuellen, im Kit enthaltenen Montagekomponenten wieder.

Die Bestandteile mit alphabetischem Bezug (Bsp. Ⓐ) geben die Original-Bestandteile wieder, die am Motorrad verbaut wurden.

Alle Angaben wie „rechts“ oder „links“ beziehen sich auf die Fahrtrichtung des Motorrads.

Allgemeine Warnhinweise



Achtung

Werden die auf den folgenden Seiten beschriebenen Arbeitsmaßnahmen nicht fachgerecht ausgeführt, kann sich dies auf die Sicherheit des Fahrers auswirken.



Achtung

Werden die auf den folgenden Seiten beschriebenen Arbeitsmaßnahmen nicht fachgerecht ausgeführt, kann sich dies auf die Sicherheit des Fahrers auswirken.



Hinweis

Für die Montage des Kits sind folgende Unterlagen erforderlich: Werkstatthandbuch, des sich in Ihrem Besitz befindlichen Motorrads.



Hinweis

Sollte sich der Austausch eines Bestandteils des Kits als erforderlich erweisen, ist dazu Bezug auf die beiliegende Ersatzteilliste zu nehmen.

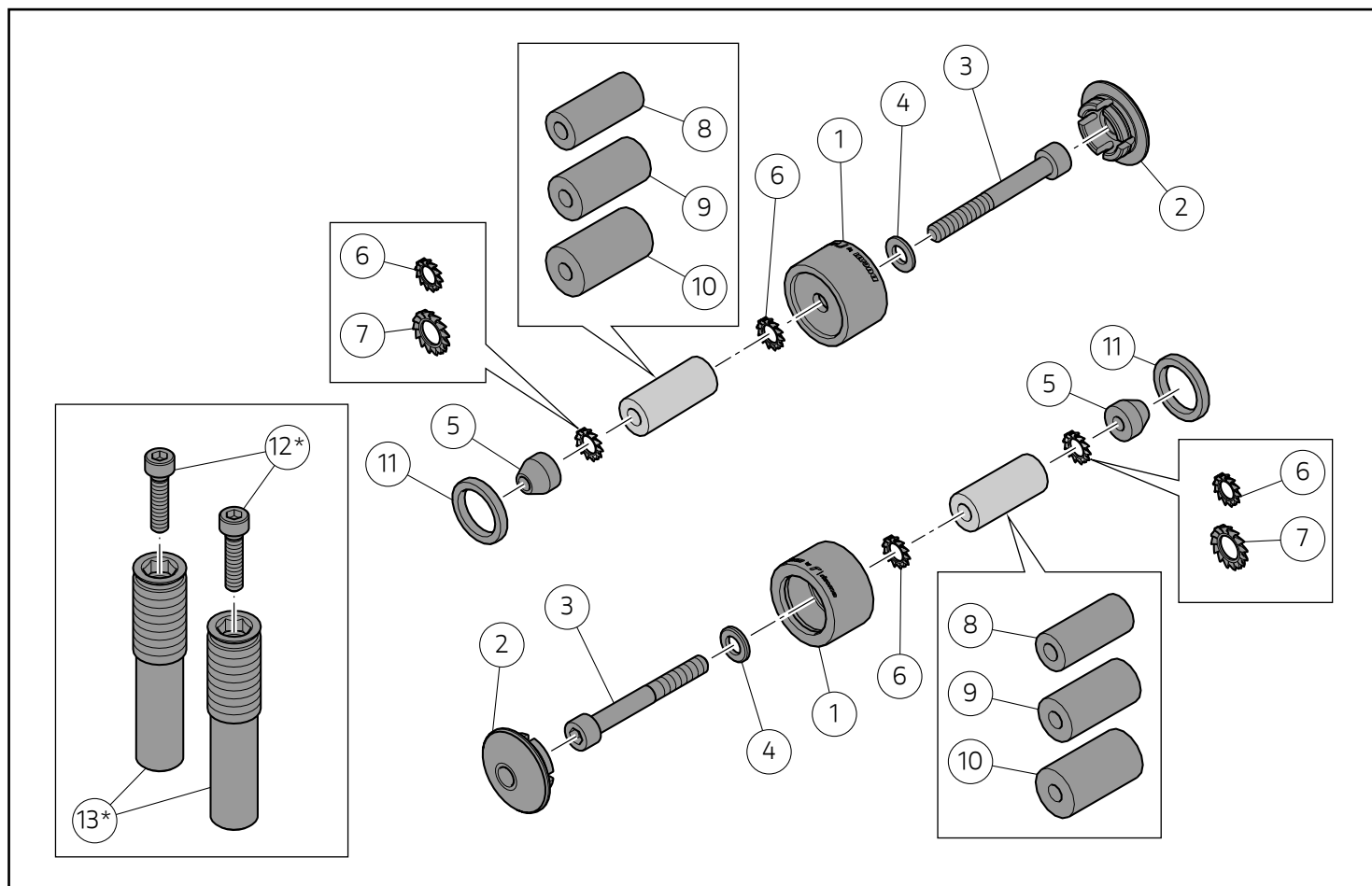

● Important

Les composants du kit peuvent être soumis à des mises à jour ; veuillez consulter le DCS (Dealer Communication System) pour des informations toujours actualisées.

👁 Remarques

Les pièces marquées du symbole (*) composent le kit adaptateurs embouts guidon, qui doit être combiné au kit embouts guidon seulement pour les motocycles :

- Panigale 899 ; 959 ; 1199 ; 1299
- Panigale R

● Wichtig

Die Bestandteile des Kits können Aktualisierungen unterliegen. Lesen Sie stets die Angaben im DCS (Dealer Communication System), um Informationen zur Verfügung stehen zu haben, die immer auf dem aktuellen Stand sind.

👁 Hinweise

Bei den mit dem Symbol (*) gekennzeichneten Bestandteilen handelt es sich um die Bestandteile des Kits Adapter Lenkerabschlussstopfen, das nur bei folgenden Modellen mit dem Kit der Lenkerabschlussstopfen darf:

- Panigale 899; 959; 1199; 1299
- Panigale R

Pos.	Dénomination	Bezeichnung
1	Embout guidon	Lenkerabschlussstopfen
2	Bouchon	Verschluss
3	Vis M6x70	Schraube M6x70
4	Rondelle	Unterlegscheibe
5	Bague	Buchse
6	Rondelle crantée Ø 6	Zahnscheibe Ø 6
7	Rondelle crantée Ø 8	Zahnscheibe Ø 8
8	Extenseur Ø 13	Spreizer Ø 13
9	Extenseur Ø 15	Spreizer Ø 15
10	Extenseur Ø 17	Spreizer Ø 17
11	Entretoise	Distanzstück
12*	Vis TCHC M6x25	Zylinderschraube mit Innensechskant M6x25
13*	Pivot fileté	Gewindebolzen

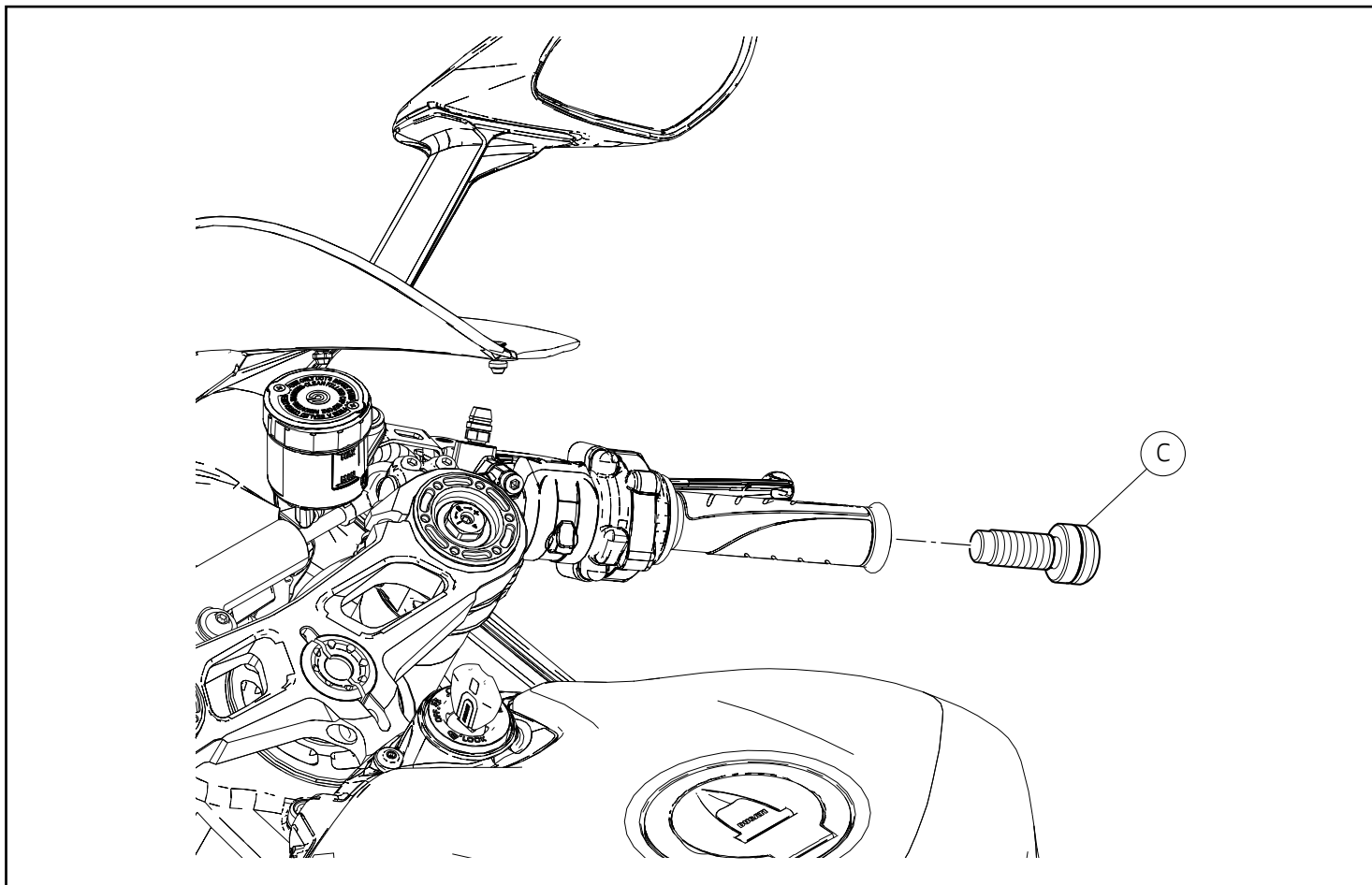

Dépose des composants d'origine

Remarques

La procédure de dépose des composants d'origine et de pose des composants du kit est la même pour tous les motocycles :

- Panigale 899 ; 959 ; 1199 ; 1299
- Panigale R

Remarques

La procédure de dépose des composants d'origine est la même pour tous les motocycles énumérés ci-dessus, c'est pourquoi on utilise comme exemple la procédure à adopter sur le modèle Panigale 1299.

En agissant du côté droit du motocycle, déposer l'ensemble contrepoids droit (C).

Répéter la même opération pour déposer l'ensemble contrepoids gauche.

Abnahme der Original-Bestandteile

Hinweise

Das Abnahmeverfahren der Original-Bestandteile und das Montageverfahren der Bestandteile des Kits ist für alle Motorradversionen gleich:

- Panigale 899; 959; 1199; 1299
- Panigale R

Hinweise

Das für die Abnahme der Original-Bestandteile anzuwendende Verfahren trifft auf alle oben aufgelisteten Motorräder zu, daher wurde das am Modell Panigale 1299 zu befolgende Verfahren als Beispiel herangezogen.

An der rechten Seite des Motorrads die rechte Gegengewichteinheit (C) entfernen.

Das gleiche Verfahren zum Entfernen der linken Gegengewichteinheit wiederholen.

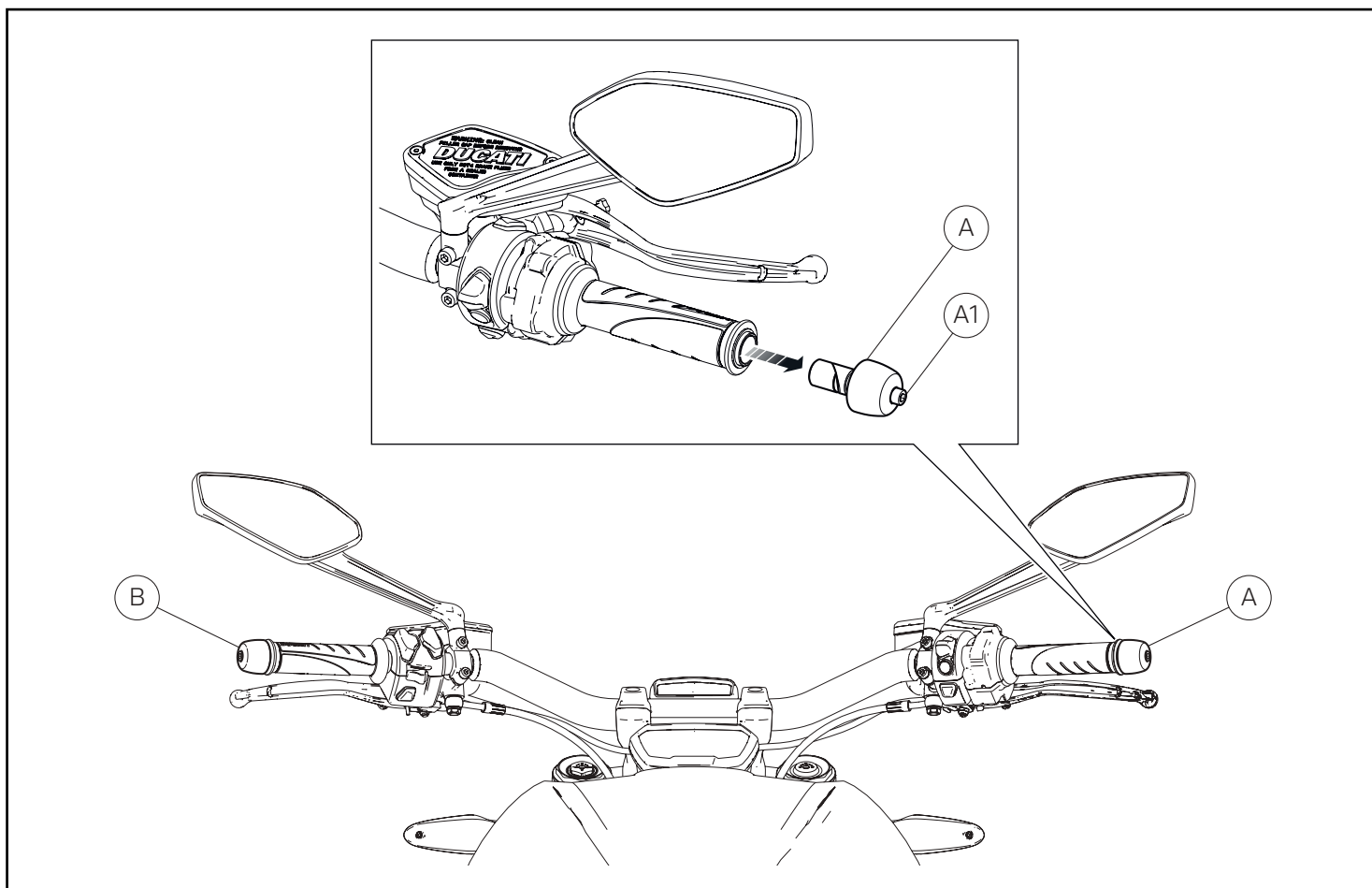

Remarques

La procédure de dépose des composants d'origine est la même pour tous les motocycles :

- Diavel
- Monster 659 ; 797 ; 821 ; 1200
- XDiavel
- Supersport

Remarques

La procédure de dépose des composants d'origine est la même pour tous les motocycles énumérés ci-dessus, c'est pourquoi on utilise comme exemple la procédure à adopter sur le modèle XDiavel.

En agissant du côté droit du motocycle, desserrer (pas complètement) la vis (A1) et déposer l'ensemble contrepoids droit (A).

Répéter la même opération pour déposer l'ensemble contrepoids gauche (B).

Hinweise

Das Verfahren für das Entfernen der Original-Bestandteile ist bei allen Versionen gleich:

- Diavel
- Monster 659; 797; 821; 1200
- XDiavel
- Supersport

Hinweise

Das für die Abnahme der Original-Bestandteile anzuwendende Verfahren trifft auf alle oben aufgelisteten Motorräder zu, daher wurde das am Modell XDiavel zu befolgende Verfahren als Beispiel herangezogen.

An der rechten Seite des Motorrads die Schraube (A1) lockern und dabei darauf achten, sie nicht vollkommen zu lösen, dann die rechte Gegengewichteinheit (A) entfernen.

Das gleiche Verfahren zum Entfernen der linken Gegengewichteinheit (B) wiederholen.

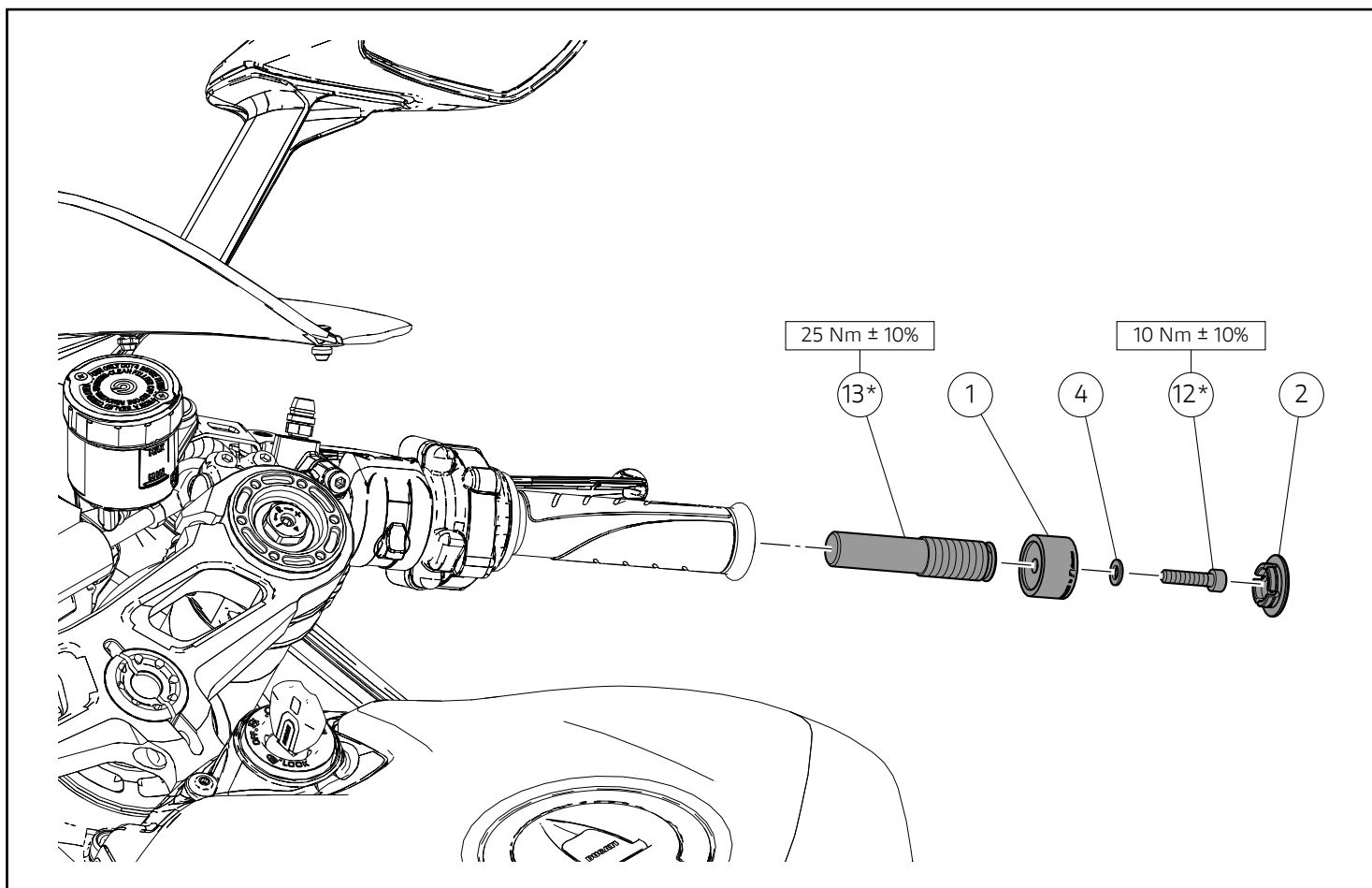

Pose des composants kit

● Important

Avant la pose, vérifier que tous les composants sont propres et en bon état. Prendre toutes les précautions nécessaires pour éviter d'endommager toute partie dans laquelle on intervient.

👁 Remarques

La procédure de pose des composants du kit est la même pour tous les motocycles :

- Panigale 899 ; 959 ; 1199 ; 1299
- Panigale R

👁 Remarques

La procédure de pose des composants du kit est la même pour tous les motocycles énumérés ci-dessus, c'est pourquoi on utilise comme exemple la procédure à adopter sur le modèle Panigale 1299.

Pose embout guidon

Enduire de LOCTITE 222 le filetage du pivot (13*). Présenter et serrer le pivot (13*) sur le demi-guidon au couple prescrit. Insérer la rondelle (4) sur le filetage de la vis (12*). Positionner l'embout guidon (1) sur le demi-guidon et présenter la vis (12*). Serrer la vis (12*) au couple prescrit. Poser le bouchon (2) sur l'embout guidon (1).

Répéter la même opération pour poser l'embout guidon sur le côté gauche du motocycle.

Montage der Kit-Bestandteile

● Wichtig

Vor der Montage überprüfen, dass alle Bestandteile sauber sind und sich im perfekten Zustand befinden. Alle erforderlichen Vorichtsmaßnahmen treffen, um eine Beschädigung des jeweiligen Bereichs, in den man arbeitet, zu vermeiden.

👁 Hinweise

Das Montageverfahren für die im Kit enthaltenen Bestandteile ist für alle Versionen gleich:

- Panigale 899; 959; 1199; 1299
- Panigale R

👁 Hinweise

Das bei der Montage der Kit-Bestandteile anzuwendende Verfahren trifft auf alle oben aufgelisteten Motorräder zu, daher wurde das am Modell Panigale 1299 zu befolgende Verfahren als Beispiel herangezogen.

Montage des Lenkerabschlusstoppers

LOCTITE 222 auf das Gewinde des Bolzens (13*) auftragen. Den Bolzen (13*) am Lenkerstummel ansetzen und mit dem angegebenen Anzugsmoment anziehen. Die Unterlegscheibe (4) auf das Gewinde der Schraube (12*) fügen. Den Lenkerabschlusstoppfen (1) am Lenkerstummel anordnen und die Schraube (12*) ansetzen. Die Schraube (12*) mit dem angegebenen Anzugsmoment anziehen. Den Verschluss (2) am Lenkerabschlusstoppfen (1) montieren.

Das gleiche Verfahren zur Montage des Lenkerabschlusstoppers an der linken Seite des Motorrads wiederholen.

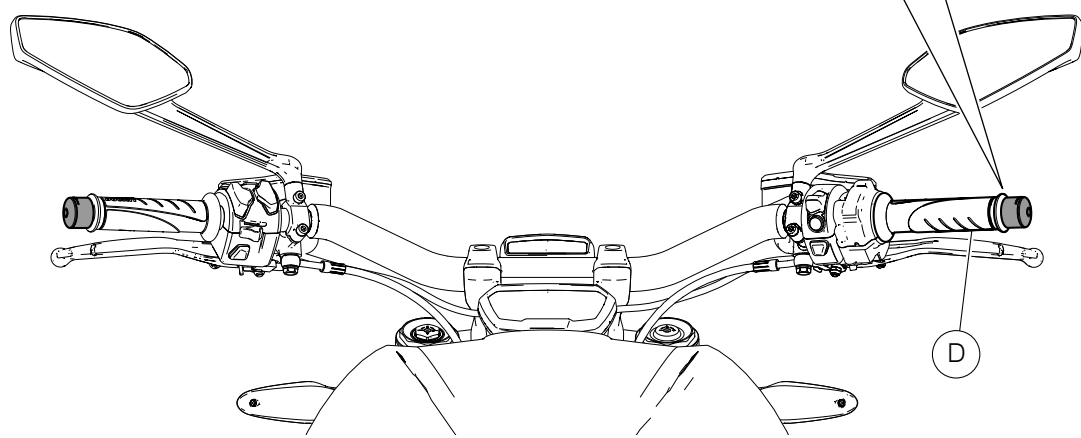
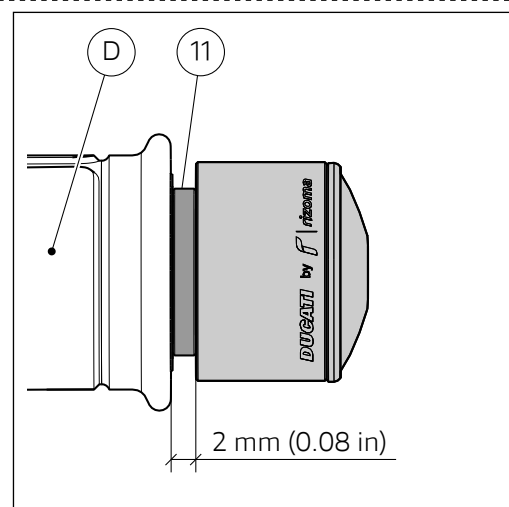
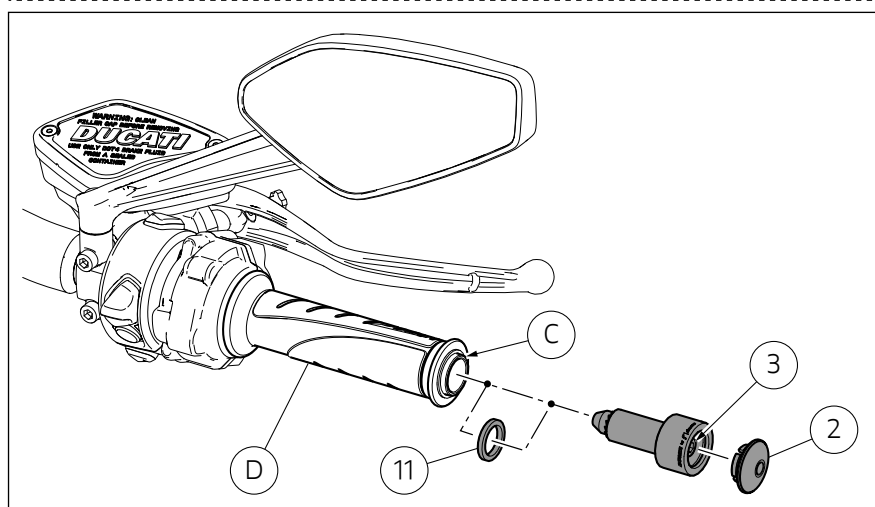
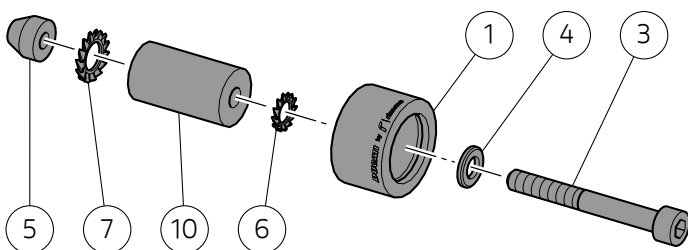
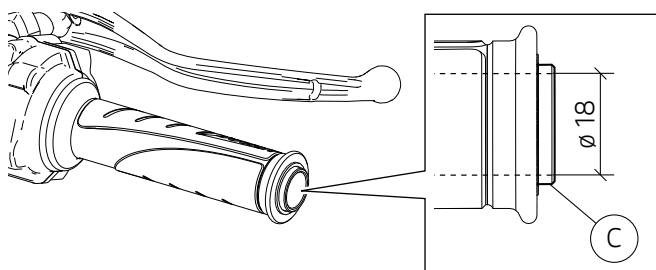
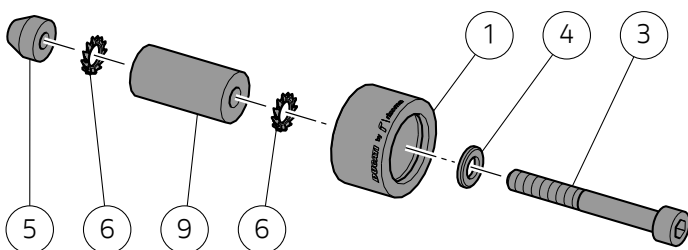
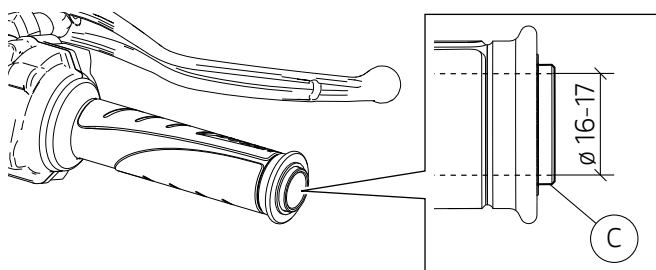
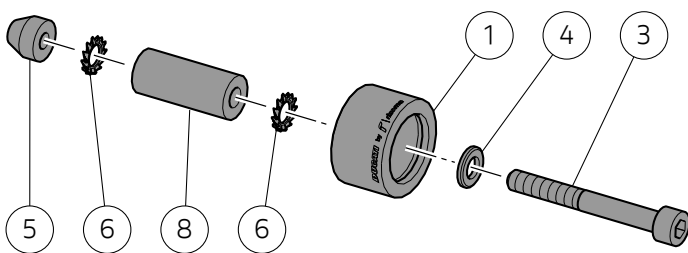
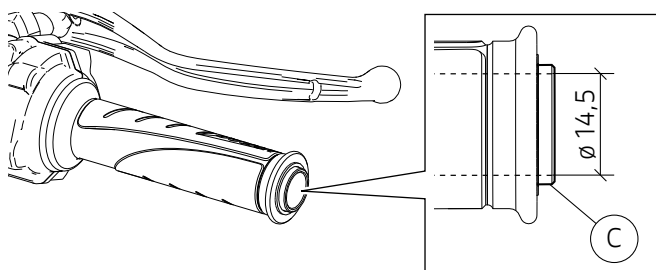



Remarques

La procédure de pose des composants du kit est la même pour tous les motocycles :

- Diavel
- Monster 659 ; 797 ; 821 ; 1200
- XDiavel
- Supersport



Remarques

La procédure de dépose des composants d'origine est la même pour tous les motocycles énumérés ci-dessus, c'est pourquoi on utilise comme exemple la procédure à adopter sur le modèle XDiavel.

Pré-installation embout guidon

Insérer la rondelle (4) sur le filet de la vis (3). Insérer la vis (3) sur l'embout guidon (1). Du côté opposé, insérer la rondelle crantée (6) sur le filet de la vis (3).



Important

Les extenseurs (8), (9), (10) et les rondelles crantées (6), (7) alternent les uns avec les autres, selon le diamètre interne du guidon (C).

Insérer l'extenseur et la rondelle appropriée sur le filetage de la vis (3), puis visser la bague (5).

Pose embout guidon

En agissant du côté droit du motorcycle, poser l'ensemble embout jusqu'en butée dans le guidon (C), en veillant à ce que la distance entre l'embout de la commande des gaz (D) et l'ensemble embout guidon ne soit pas inférieure à 2 mm (0.08 in).



Attention

Au cas où cette distance serait inférieure à 2 mm (0.08 in), il faudra poser l'entretoise (11).



Attention

Une fois la pose terminée, vérifier que la commande des gaz (D) tourne librement jusqu'en butée.

Serrer la vis (3) jusqu'à ce que l'ensemble embout soit bloqué sur le guidon (C). Poser le bouchon (2) sur l'ensemble embout guidon.

Répéter la même opération pour poser l'embout guidon sur le côté gauche du motorcycle.



Hinweise

Das Montageverfahren für die im Kit enthaltenen Bestandteile ist für alle Versionen gleich:

- Diavel
- Monster 659; 797; 821; 1200
- XDiavel
- Supersport



Hinweise

Das für die Abnahme der Original-Bestandteile anzuwendende Verfahren trifft auf alle oben aufgelisteten Motorräder zu, daher wurde das am Modell XDiavel zu befolgende Verfahren als Beispiel herangezogen.

Vormontage des Lenkerabschlusstopfens

Die Unterlegscheibe (4) auf das Gewinde der Schraube (3) stecken. Die Schraube (3) in den Lenkerabschlusstopfen (1) einfügen. An der gegenüberliegenden Seite die Zahnscheibe (6) auf das Gewinde der Schraube (3) stecken.



Wichtig

Die Spreizer (8), (9) und (10) sowie die Zahnscheiben (6) und (7) sind in Abhängigkeit des Innendurchmessers des Lenkers (C) zu wählen.

Den Spreizer und die passende Zahnscheibe auf das Gewinde der Schraube (3) stecken und dann die Buchse (5) anschrauben.

Montage des Lenkerabschlusstopfens

An der rechten Seite des Motorrads die Abschlusstopfeneinheit so am Lenker (C) anmontieren, dass sie den Anschlag erreicht und überprüfen, dass der Abstand zwischen dem Endstück der Gassteuerung (D) und der Lenkerstopfeneinheit nicht geringer als 2 mm (0.08 in) ist.



Achtung

Sollte der Abstand geringer als 2 mm (0.08 in) sein, muss das Distanzstück (11) montiert werden.



Achtung

Nach erfolgter Montage überprüfen, dass die Gassteuerung (D) sich frei auf ihren Hub drehen kann.

Die Schraube (3) so lange anziehen bis die Lenkerabschlusstopfeneinheit gut am Lenker (C) befestigt ist. Die Verschlusskappe (2) an der Lenkerabschlusstopfeneinheit anbringen.

Das gleiche Verfahren zur Montage des Lenkerabschlusstopfens an der linken Seite des Motorrads wiederholen.

Conjunto terminais de guidador - 97380951AA (Preto) - 97380951AB (Vermelho)

Conjunto adaptadores para terminais de guidador - 97380961A

Handlebar end cap kit - 97380951AA (Black) - 97380951AB (Red)

Handlebar end cap adapter kit - 97380961A

Símbolos

Para uma leitura rápida e racional, foram utilizados símbolos que evidenciam situações de máxima atenção, conselhos práticos ou simples informações. Preste muita atenção ao significado dos símbolos, pois a sua função é a de evitar a repetição de conceitos técnicos ou de avisos de segurança. Portanto, os símbolos devem ser considerados como verdadeiros "lembretes". Consulte esta página sempre que tiver dúvidas acerca do seu significado.



Atenção

O não cumprimento das instruções mostradas pode criar uma situação de perigo e causar graves lesões pessoais e até mesmo a morte.



Importante

Indica a possibilidade de causar danos ao veículo e/ou aos seus componentes se as instruções mostradas não forem executadas.



Notas

Fornecer informações úteis sobre a operação em curso.

Referências

Os detalhes evidenciados em cinza e com referência numérica (Ex. ①) representam o acessório a ser instalado e os eventuais componentes de montagem fornecidos como kit.

Os detalhes com referência alfabética (Ex. ①) representam os componentes originais presentes na moto.

Todas as indicações direita ou esquerda, referem-se ao sentido de marcha da moto.

Advertências gerais



Atenção

As operações mostradas nas páginas a seguir, se não forem executadas com boa técnica, podem prejudicar a segurança do condutor.



Atenção

As operações mostradas nas páginas a seguir, se não forem executadas com boa técnica, podem prejudicar a segurança do condutor.



Notas

Documentação necessária para executar a montagem do Conjunto: Manual De Oficina, relativo ao modelo de moto em sua posse.



Notas

Caso seja necessária a substituição de um componente do conjunto, consulte o quadro de peças de reposição em anexo.

Symbols

To allow quick and easy consultation, this manual uses graphic symbols to highlight situations in which maximum care is required, as well as practical advice or information. Pay attention to the meaning of the symbols since they serve to avoid repeating technical concepts or safety warnings throughout the text. The symbols should therefore be seen as real reminders. Please refer to this page whenever in doubt as to their meaning.



Warning

Failure to follow these instructions might give rise to a dangerous situation and provoke severe personal injuries or even death.



Caution

Failure to follow these instructions might cause damages to the vehicle and/or its components.



Notes

Useful information on the procedure being described.

References

Parts highlighted in grey and with a numeric reference (Example ①) are the accessory to be installed and any assembly components supplied with the kit.

Parts with an alphabetic reference (Example ①) are the original components fitted on the vehicle.

Any right- or left-hand indication refers to the vehicle direction of travel.

General notes



Warning

Carefully perform the operations on the following pages since they might negatively affect rider safety.



Warning

Carefully perform the operations on the following pages since they might negatively affect rider safety.



Notes

The following documents are necessary for assembling the Kit: Workshop Manual of your bike model.



Notes

Should it be necessary to change any kit parts, please refer to the attached spare part table.



Warning

Operating, servicing and maintaining a passenger vehicle or off-highway motor vehicle can expose you to chemicals including engine exhaust, carbon monoxide, phthalates, and lead, which are known to the State of California to cause cancer and birth defects or other reproductive harm. To minimize exposure, avoid breathing exhaust, do not idle the engine except as necessary, service your vehicle in a well-ventilated area and wear gloves or wash your hands frequently when servicing your vehicle. For more information go to www.P65Warnings.ca.gov/passenger-vehicle.

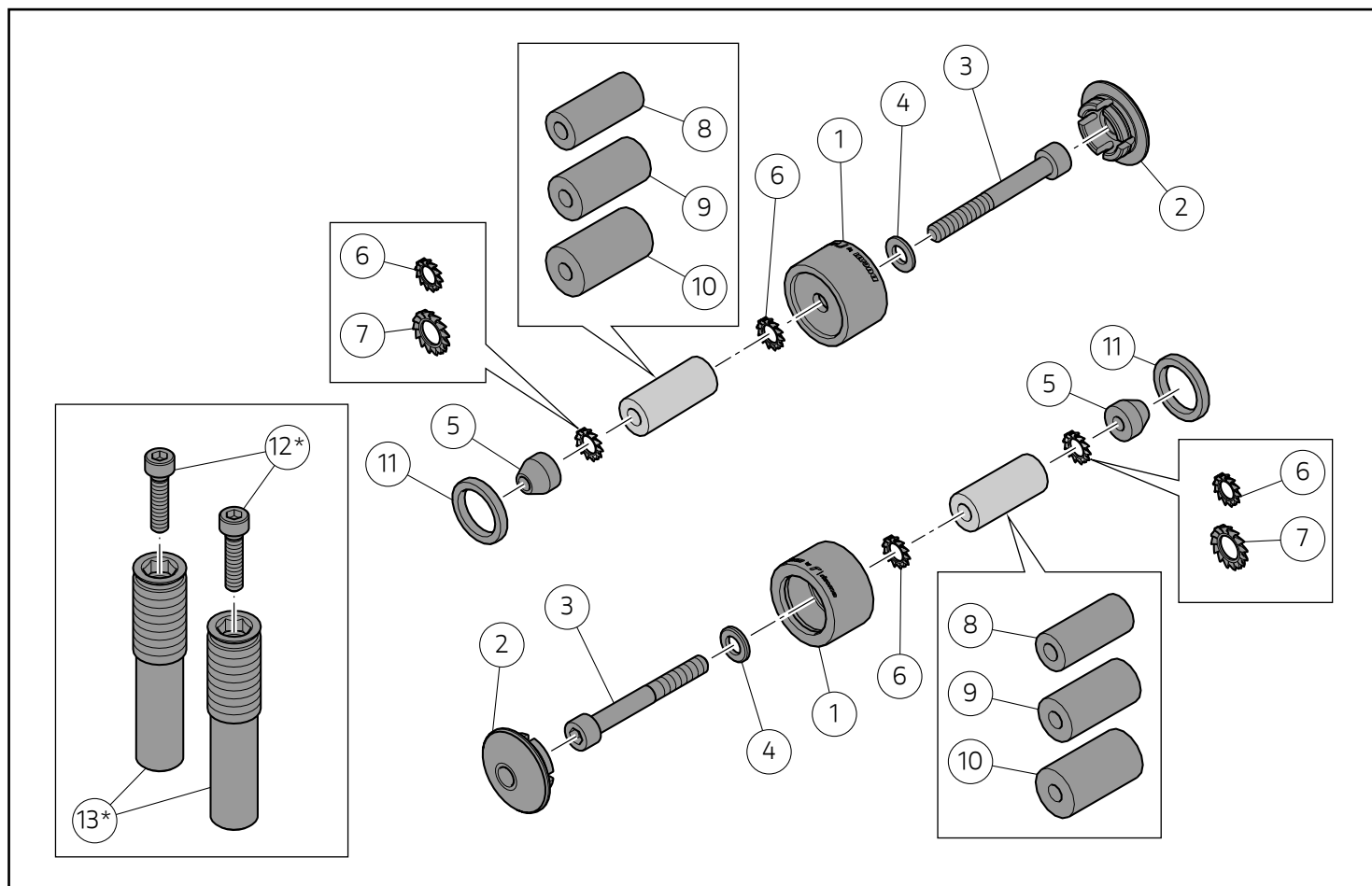

Importante

Os componentes do conjunto podem sofrer atualizações; consulte o DCS (Dealer Communication System) a fim de obter informações sempre atualizadas.

Notas

As peças marcadas com o símbolo (*) compõem o conjunto adaptadores para terminais de guidador, o qual deve ser combinado ao conjunto terminais de guidador apenas para as motos:

- Panigale 899; 959; 1199; 1299
- Panigale R

Important

The parts of the kit can be updated; for information always up to date, please refer to DCS (Dealer Communication System).

Notes

The parts indicated with the symbol (*) make up the handlebar end cap adapter kit, which must be matched with handlebar end cap kit only for the following motorcycles:

- Panigale 899; 959; 1199; 1299
- Panigale R

Pos.	Denominação	Description
1	Terminal do guidador	Handlebar end cap
2	Tampa	Plug
3	Parafuso M6x70	Screw M6x70
4	Arruela	Washer
5	Casquilho	Bushing
6	Arruela dentada Ø 6	Toothed washer Ø 6
7	Arruela dentada Ø 8	Toothed washer Ø 8
8	Expansor Ø 13	Expander Ø 13
9	Expansor Ø 15	Expander Ø 15
10	Expansor Ø 17	Expander Ø 17
11	Espaçador	Spacer
12*	Parafuso de cabeça cilíndrica com sextavado interno M6x25	TCEI screw M6x25
13*	Perno roscado	Threaded pin

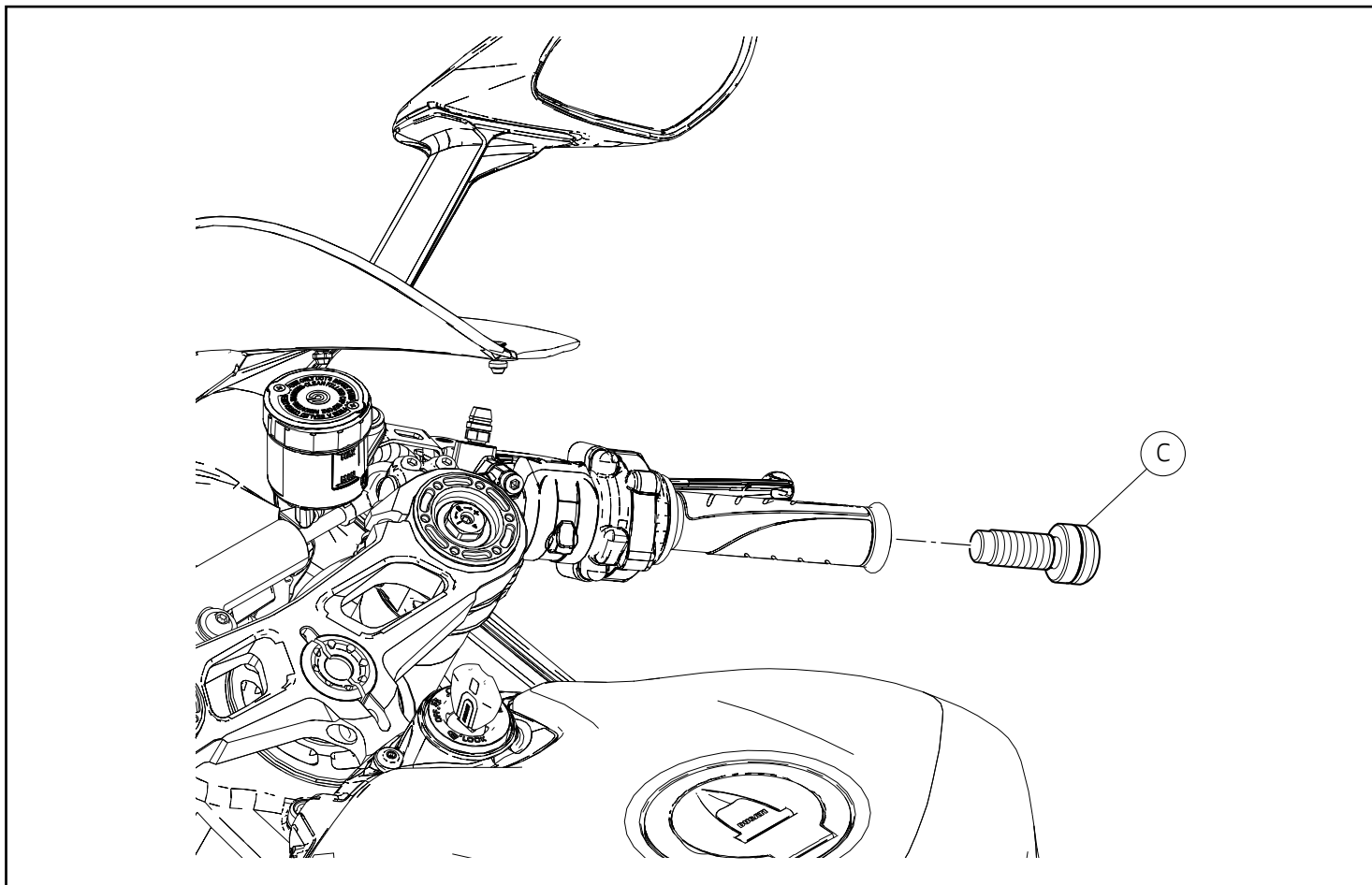

Desmontagem dos componentes originais



Notas

O procedimento de desmontagem dos componentes originais e dos componentes do conjunto é o mesmo para todas as motos:

- Panigale 899; 959; 1199; 1299
- Panigale R



Notas

O procedimento de desmontagem dos componentes originais é o mesmo para todas as motos listadas acima, pelo que é utilizado, como exemplo, o procedimento a adotar no modelo Panigale 1299.

Operando no lado direito da moto, remova o grupo contrapeso direito (C).

Repita a mesma operação para remover o grupo contrapeso esquerdo.

Removing the original components



Notes

The procedure to remove original components and assembly kit components is the same for all motorcycles:

- Panigale 899; 959; 1199; 1299
- Panigale R



Notes

The original component removal procedure is the same for all the motorcycles listed above. The procedure for the Panigale 1299 model will be described here as a general example.

Working on RH side of the motorcycle, remove RH balancing weight assembly (C).

Repeat the same operation to remove LH balancing weight assembly.

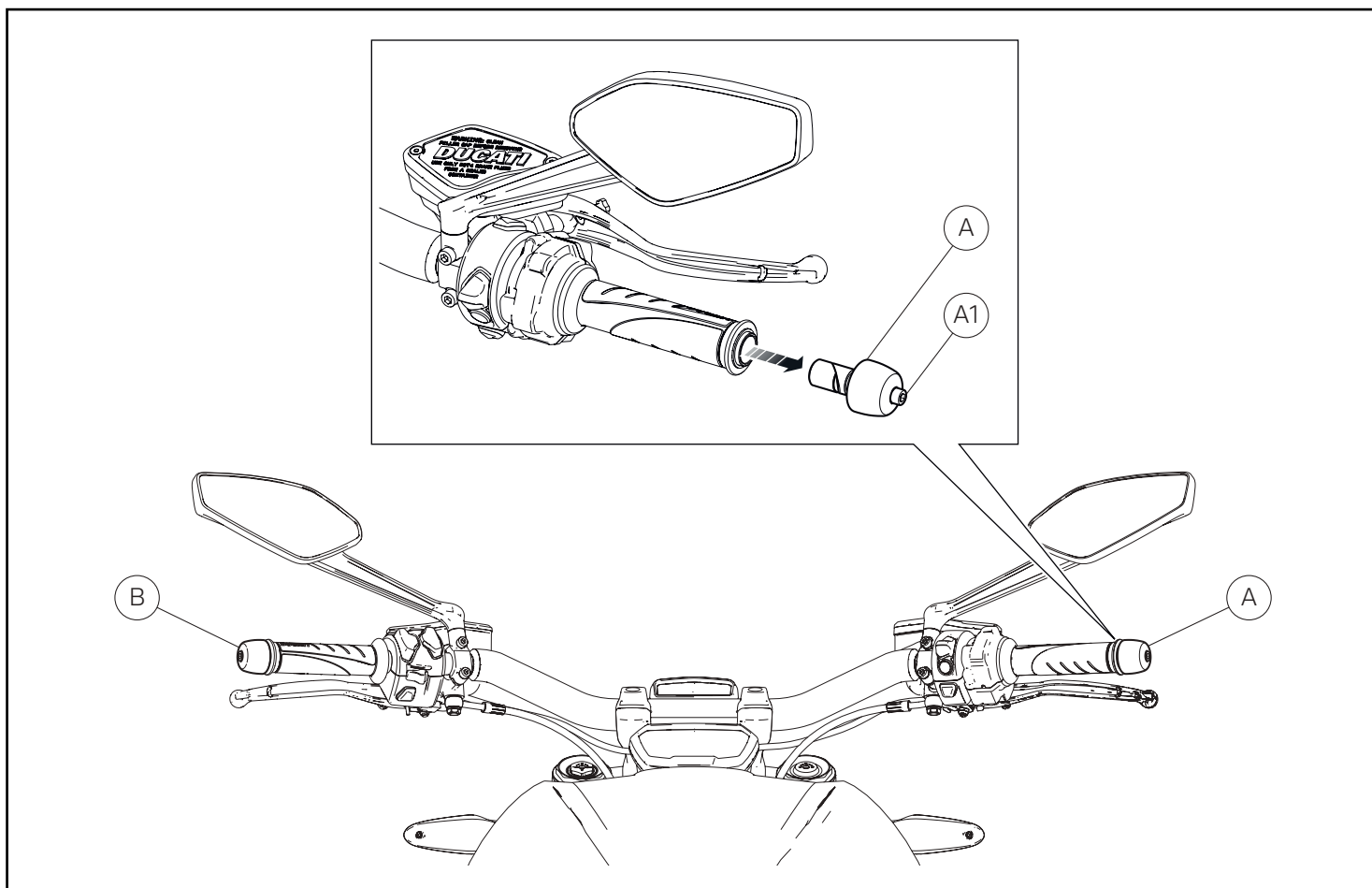

Notas

O procedimento de desmontagem dos componentes originais é o mesmo para todas as motos:

- Diavel
- Monster 659; 797; 821; 1200
- XDiavel
- Supersport

Notas

O procedimento de desmontagem dos componentes originais é o mesmo para todas as motos listadas acima, pelo que é utilizado, como exemplo, o procedimento a adotar no modelo XDiavel.

Atuando no lado direito da moto, alivie, prestando muita atenção para não desatarraxar completamente o parafuso (A1) e remova o grupo contrapeso direito (A).

Repita a mesma operação para remover o grupo do contrapeso esquerdo (B).

Notes

The original component removal procedure is the same for all motorcycles:

- Diavel
- Monster 659; 797; 821; 1200
- XDiavel
- Supersport

Notes

The original component removal procedure is the same for all the motorcycles listed above. The procedure for the XDiavel model will be described here as a general example.

Working on motorcycle RH side, loosen screw (A1) paying attention not to unscrew it completely and remove RH balancing weight assembly (A).

Repeat the same procedure to remove LH balancing weight assembly (B).

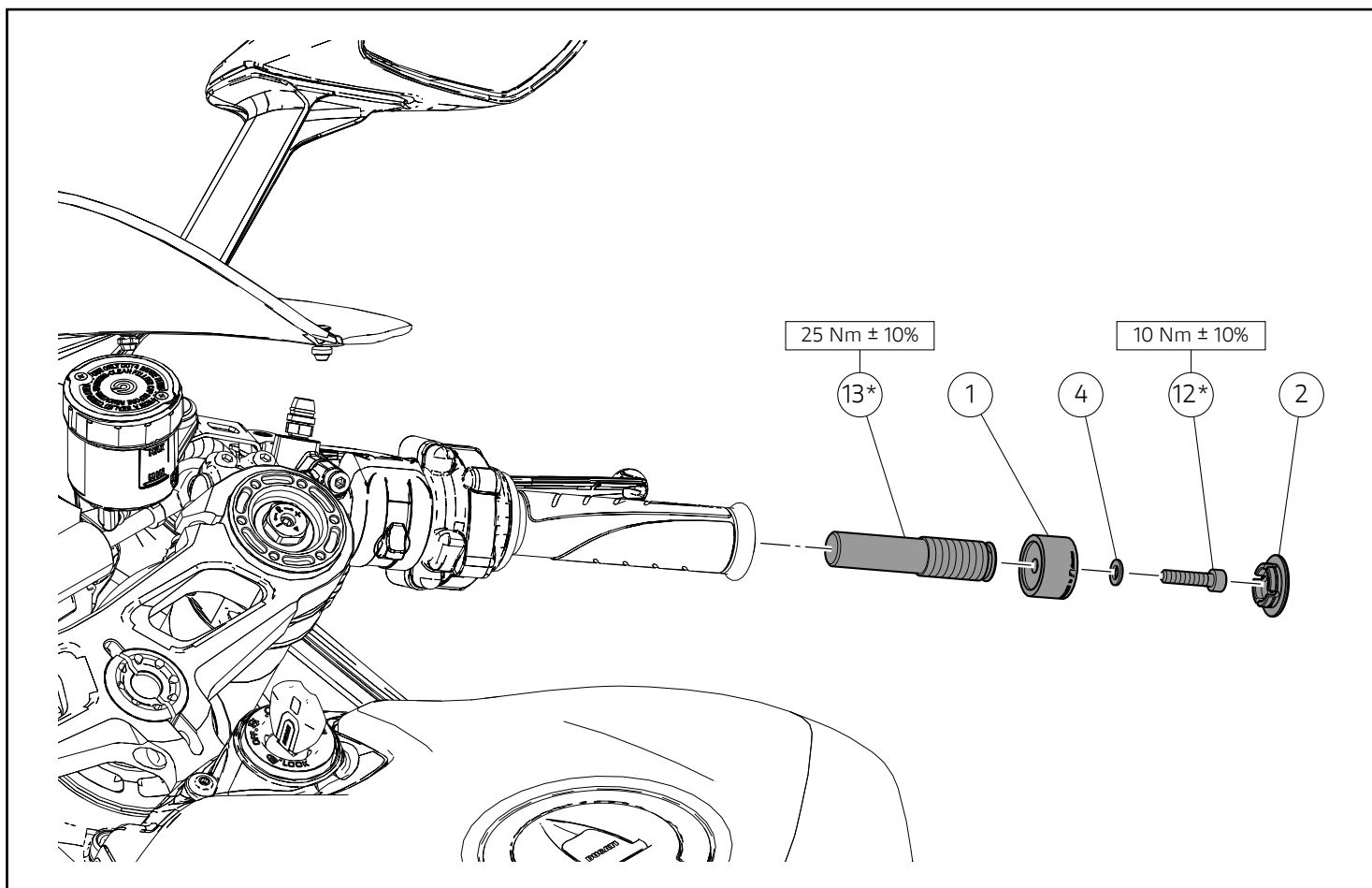

Montagem dos componentes do conjunto

● Importante

Verifique, antes da montagem, se todos os componentes estão limpos e em perfeito estado. Adote todas as precauções necessárias para evitar danificar qualquer peça com a qual deve trabalhar.

👁 Notas

O procedimento de montagem dos componentes do conjunto é o mesmo para todas as motos:

- Panigale 899; 959; 1199; 1299
- Panigale R

👁 Notas

O procedimento de montagem dos componentes do conjunto é o mesmo para todas as motos listadas acima, pelo que é utilizado, como exemplo, o procedimento a adotar no modelo Panigale 1299.

Montagem do terminal do guidador

Aplique LOCTITE 222 na rosca do perno (13*). Encoste e aperte o perno (13*) no avanço de guidador, ao binário indicado. Insira a arruela (4) na rosca do parafuso (12*). Posicione o terminal de guidador (1) no avanço de guidador e encoste o parafuso (12*). Aperte o parafuso (12*) ao binário indicado. Monte a tampa (2) no terminal de guidador (1).

Repita a mesma operação para a montagem do terminal do guidador no lado esquerdo da moto.

Assembling the kit components

● Important

Before assembling, check that all parts are clean and in good conditions. Adopt all necessary precautions to avoid damaging any part you are working on.

👁 Notes

The kit component assembly procedure is the same for all motorcycles:

- Panigale 899; 959; 1199; 1299
- Panigale R

👁 Notes

The kit component assembly procedure is the same for all the motorcycles listed above. The procedure for the Panigale 1299 model will be described here as a general example.

Handlebar end cap assembly

Apply LOCTITE 222 on the thread of pin (13*). Start and tighten pin (13*) on handlebar, to the specified torque. Insert washer (4) on screw (12*) thread. Position handlebar end cap (1) on handlebar and start screw (12*). Tighten screw (12*) to the specified torque. Fit plug (2) on handlebar end cap (1).

Repeat the same procedure to assembly the handlebar end cap on the motorcycle LH side.

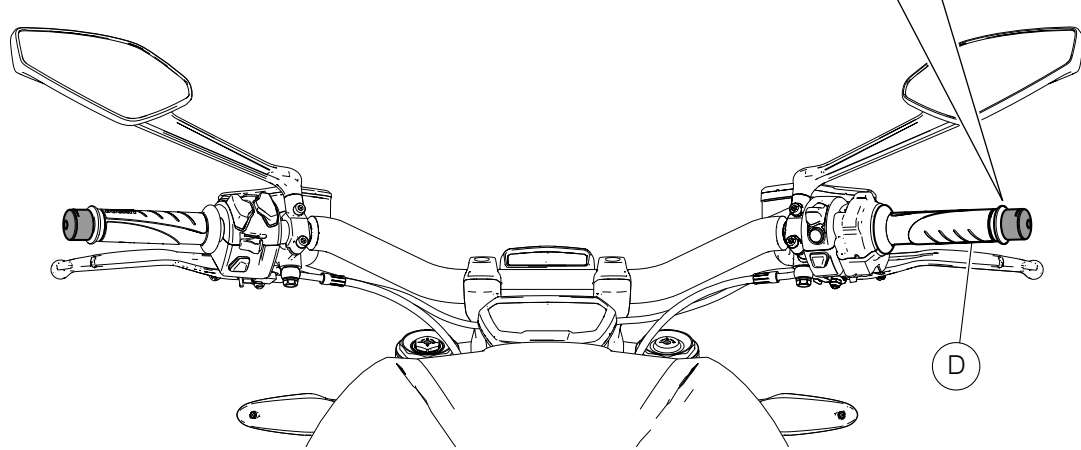
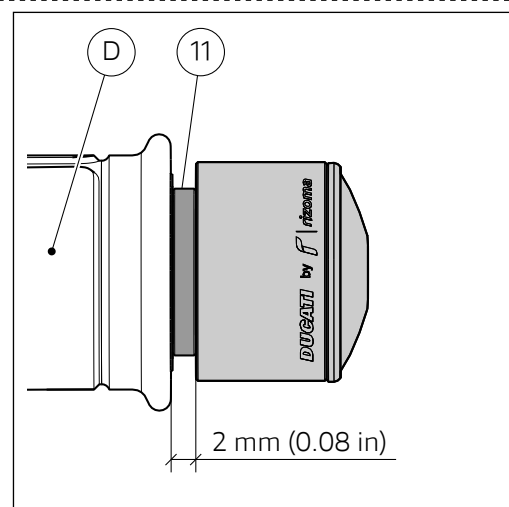
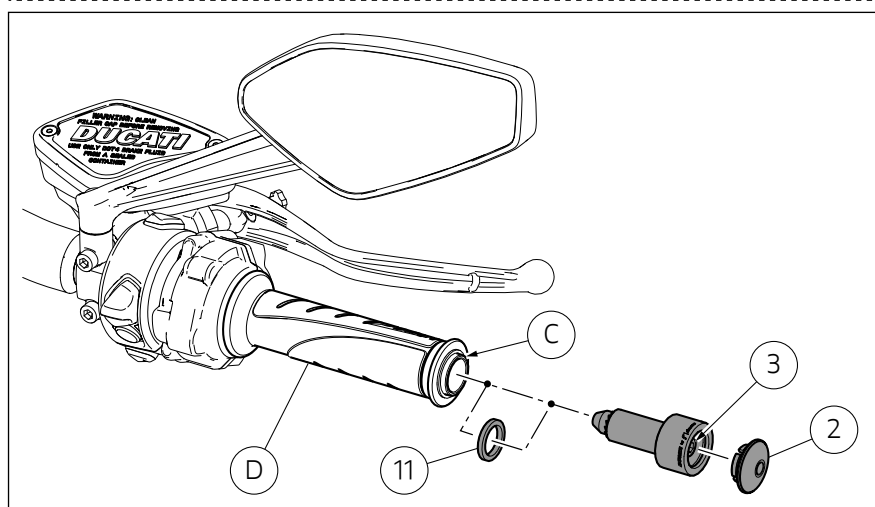
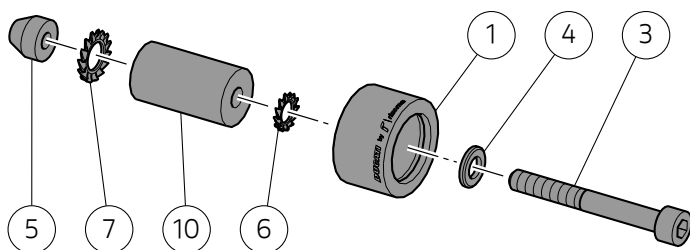
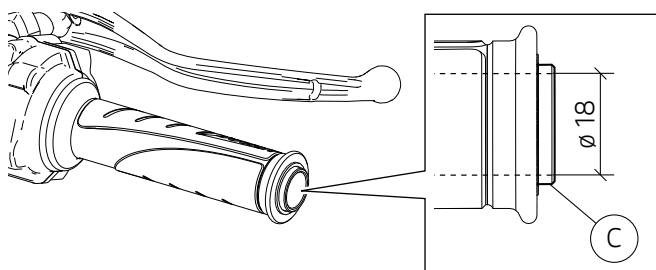
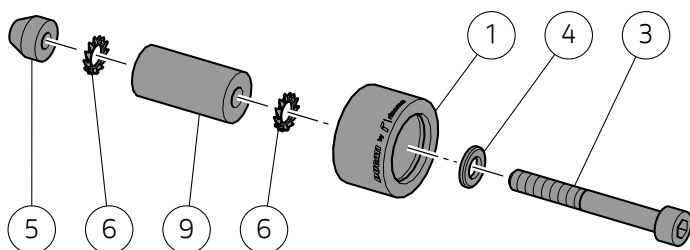
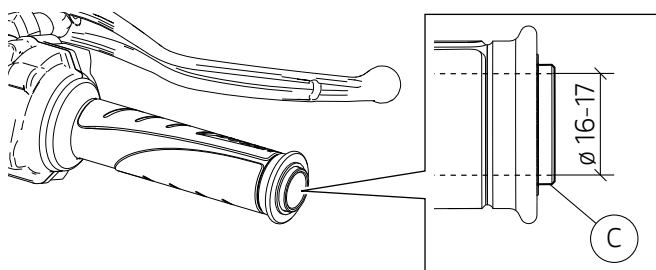
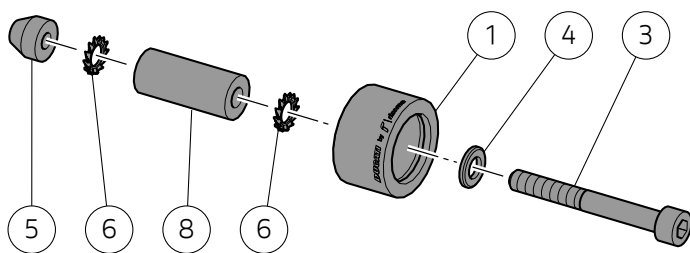
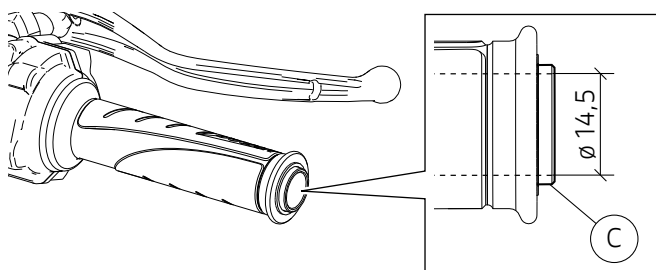

**Notas**

O procedimento de montagem dos componentes do conjunto é o mesmo para todas as motos:

- Diavel
- Monster 659; 797; 821; 1200
- XDiavel
- Supersport

**Notas**

O procedimento de desmontagem dos componentes originais é o mesmo para todas as motos listadas acima, pelo que é utilizado, como exemplo, o procedimento a adotar no modelo XDiavel.

Pré-montagem do terminal do guidador

Insira a arruela (4) na rosca do parafuso (3). Introduza o parafuso (3) no terminal do guidador (1). Pelo lado oposto, na rosca do parafuso (3), insira a arruela dentada (6).

**Importante**

Os expansores (8), (9), (10) e as arruelas dentadas (6), (7) alternam entre si, com base no diâmetro interno do guidador (C).

Insira o expansor e a arruela adequada na rosca do parafuso (3) e atarraxe o casquilho (5).

Montagem do terminal do guidador

Atuando no lado direito da moto, monte o grupo terminal, até ao fundo, no guidador (C), certificando-se de que a distância entre o terminal do comando do acelerador (D) e o grupo terminal do guidador não é inferior a 2 mm (0.08 in).

**Atenção**

Se a distância for inferior a 2 mm (0.08 in), é necessário montar o espaçador (11).

**Atenção**

Ao terminar a montagem, verifique se o comando do acelerador (D) gira livremente ao longo de todo o seu curso.

Aperte o parafuso (3) até ao bloqueio do grupo terminal no guidador (C). Monte a tampa (2) no grupo terminal do guidador.

Repita a mesma operação para a montagem do terminal do guidador no lado esquerdo da moto.

**Notes**

The kit component assembly procedure is the same for all motorcycles:

- Diavel
- Monster 659; 797; 821; 1200
- XDiavel
- Supersport

**Notes**

The original component removal procedure is the same for all the motorcycles listed above. The procedure for the XDiavel model will be described here as a general example.

Handlebar end cap pre-assembly

Insert washer (4) on screw (3) thread. Insert screw (3) on handlebar end cap (1). On the opposite side, fit toothed washer (6) on screw (3) thread.

**Important**

It is possible to alternate expanders (8), (9), (10) and toothed washers (6) and (7) according to the internal handlebar (C) diameter.

Fit the suitable expander and washer on screw (3) thread and tighten the bushing (5).

Handlebar end cap assembly

Working on motorcycle RH side, fit the end cap assembly on the handlebar (C) until it stops, checking that the distance between the throttle control end cap (D) and the handlebar end cap assembly is not less than 2 mm (0.08 in).

**Warning**

Should the distance be less than 2 mm (0.08 in), fit the spacer (11).

**Warning**

When the assembly is completed, check that the throttle control (D) turns freely along its whole stroke.

Tighten screw (3) until the end cap assembly is locked on the handlebar (C). Fit plug (2) on the handlebar end cap assembly.

Repeat the same procedure to assemble the handlebar end cap on the motorcycle LH side.

Kit terminales manillar - 97380951AA (Negro) - 97380951AB (Rojo)
 Kit adaptadores terminales manillar - 97380961A
 ハンドルバーエンドキット - 97380951AA (ブラック) - 97380951AB (レッド)
 ハンドルバーエンドアダプターキット - 97380961A

Símbolos

Para una lectura rápida y racional se han empleado símbolos que evidencian situaciones de máxima atención, consejos prácticos o simples informaciones. Prestar mucha atención al significado de los símbolos porque su función consiste en omitir la repetición de conceptos técnicos o advertencias de seguridad. Los símbolos deben considerarse como verdaderos "apuntes". Consultar esta página cada vez que se tengan dudas sobre su significado.



Atención

El incumplimiento de las instrucciones indicadas puede crear una situación de peligro y ocasionar graves lesiones e incluso la muerte.



Importante

Indica la posibilidad de provocar un daño al vehículo y/o a sus componentes si no se siguen las instrucciones indicadas.



Notas

Suministra útiles informaciones sobre la operación en curso.

Referencias

Las partes resaltadas en gris y la referencia numérica (Por ej. ①) representan el accesorio que se debe instalar y los eventuales componentes de montaje suministrados en el kit.

Las partes con referencia alfabética (Por ej. (A)) representan los componentes originales presentes en la motocicleta.

Todas las indicaciones derecha o izquierda se refieren al sentido de marcha de la motocicleta.

Advertencias generales



Atención

Las operaciones descritas en las siguientes páginas deben realizarse correctamente para no perjudicar la seguridad del piloto.



Atención

Las operaciones descritas en las siguientes páginas deben realizarse correctamente para no perjudicar la seguridad del piloto.



Notas

La documentación necesaria para realizar el montaje del Kit es el: Manual De Taller, relativo al modelo de moto en vuestro poder.



Notas

Si fuera necesario sustituir un componente del kit, consultar la tabla de recambios adjunta.

シンボル

素早くかつ合理的に読み進めることができるように、本マニュアルではいくつかのシンボルを導入し、最大限の注意を払う必要がある状況や、推奨事項、または一般情報を明確にしてあります。技術的概念や安全に関する警告を繰り返し記載する必要がないように機能しているので、各シンボルの意味に十分注意してください。シンボルは、実際上の“覚え書き”であると考えてください。シンボルなどの意味がわからなくなったり疑問に思う場合は、必ずこのページで調べるようにしてください。



注記

この説明書に従わずに使用すると危険な状況を招き、重大なけが、あるいは死をももたらす原因となることがあります。



重要

この説明書に従わずに使用すると、車体及び/又はその部品に損害を招く可能性があります



参考

操作中の内容に関する有用な情報を掲載しています。

参照

灰色で表示する部品、および参照番号 (Es.①) で表示する部品は、キットに付属する取り付け部品および組み立て部品を示します。

参照アルファベット (Es.(A)) で表示する部品は、車両に付属するオリジナル部品を示します。

すべての右及び左の指示は車体の進行方向を向いたものです。

一般警告事項



注記

以下のページに記載されている作業が規定通りに実施されないと、ライダーの安全性を脅かすおそれがあります。



注記

以下のページに記載されている作業が規定通りに実施されないと、ライダーの安全性を脅かすおそれがあります。



参考

キットの取り付けに必要な資料：お手持ちの車両モデルに対応するワークショップマニュアル。



参考

キットの部品を交換する必要がある場合は、添付のスペアパーツ表を参照してください。

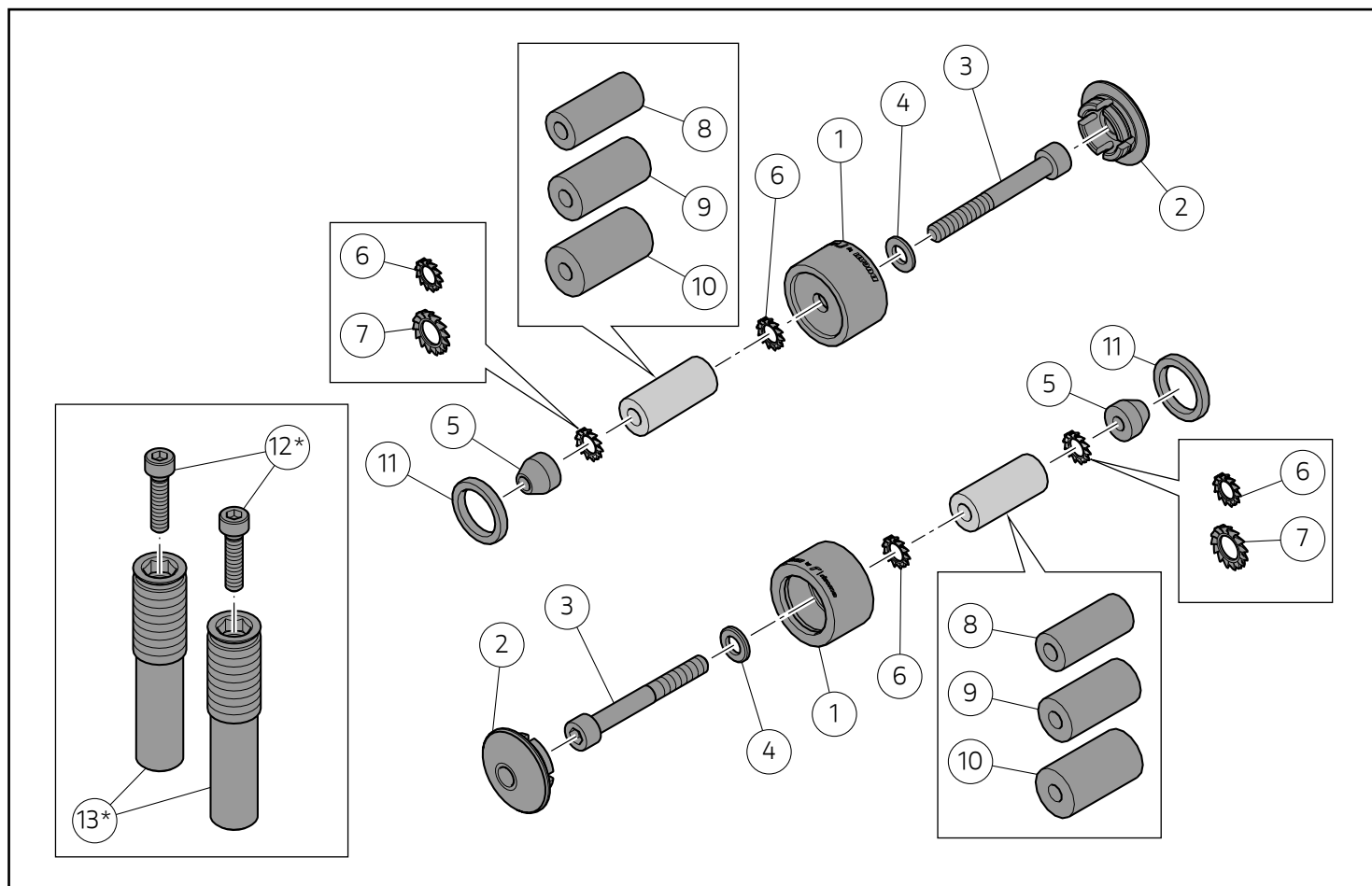

● Importante

Es posible que los componentes del kit sean actualizados; consultar el DCS (Dealer Communication System) para tener información siempre al día.

👁️ Notas

Los componentes marcados con el símbolo (*) componen el kit adaptadores terminales manillar, que se debe combinar con el kit terminales manillar solo para las motos:

- Panigale 899; 959; 1199; 1299
- Panigale R

● 重要

キットの構成部品は更新されることがあります。DCS (Dealer Communication System) から常に最新の情報をチェックするようにしてください。

👁️ 参考

(*) マークの付与されている部品は、ハンドルバーエンドアダプターキットを構成する部品です。これらの部品はハンドルバーエンドキットと組み合わせて、以下の車両にのみ取り付けすることができます。

- Panigale 899; 959; 1199; 1299
- Panigale R

Pos.	Denominación	名称
1	Terminal manillar	ハンドルバーエンド
2	Tapón	キャップ
3	Tornillo M6x70	スクリュー M6x70
4	Arandela	ワッシャー
5	Casquillo	ブッシュ
6	Arandela dentada Ø 6	歯付きワッシャー Ø 6
7	Arandela dentada Ø 8	歯付きワッシャー Ø 8
8	Expansor Ø 13	エキスパンダー Ø 13
9	Expansor Ø 15	エキスパンダー Ø 15
10	Expansor Ø 17	エキスパンダー Ø 17
11	Separador	スパーサー
12*	Tornillo TCEI M6x25	スクリュー TCEI M6x25
13*	Perno roscado	ネジ山付きピン

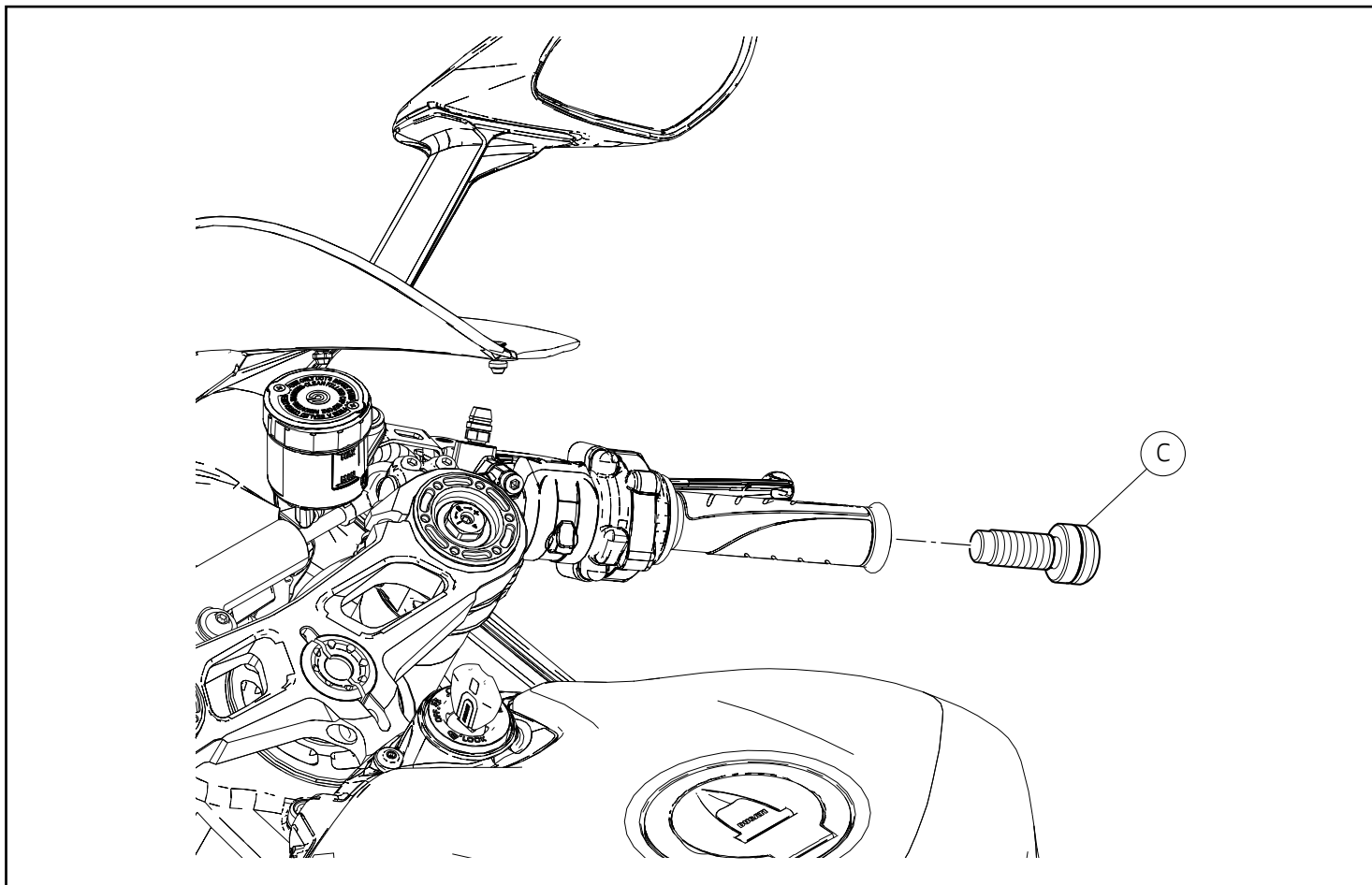

Desmontaje componentes originales



Notas

El procedimiento de desmontaje de los componentes originales y montaje de los componentes del kit es el mismo para todas las motocicletas:

- Panigale 899; 959; 1199; 1299
- Panigale R



Notas

El procedimiento de desmontaje de los componentes originales es el mismo para todas las motocicletas arriba indicadas, por tanto se utiliza como ejemplo el procedimiento que se debe adoptar en el modelo Panigale 1299.

Operando en el lado derecho de la motocicleta, quitar el grupo contrapeso derecho (C).

Repetir la misma operación para quitar el grupo contrapeso izquierdo.

オリジナル構成部品の取り外し



参考

オリジナル部品およびキット構成部品の取り外し手順は、以下のすべての車両に共通です。

- Panigale 899; 959; 1199; 1299
- Panigale R



参考

オリジナル部品の取り外し手順は、上記すべての車両に共通です。ここでは例として Panigale 1299 モデルの作業手順を記載しています。

車両の右側から、右カウンターウェイトユニット (C) を取り外します。

左カウンターウェイトユニットの取り外しについても同様の作業を繰り返します。

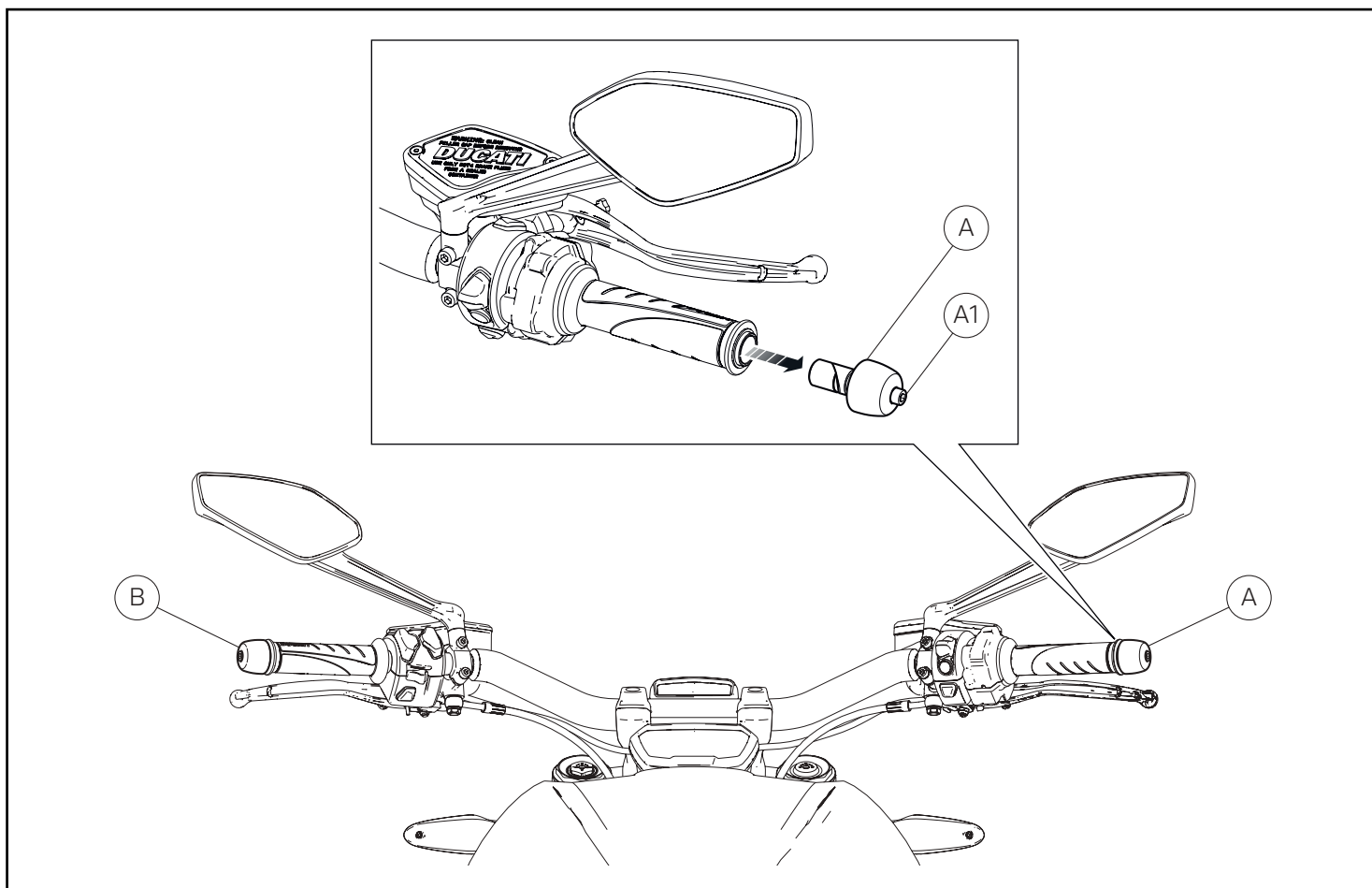

👁 Notas

El procedimiento de desmontaje de los componentes originales es el mismo para todas las motocicletas:

- Diavel
- Monster 659; 797; 821; 1200
- XDiavel
- Supersport

👁 Notas

El procedimiento de desmontaje de los componentes originales es el mismo para todas las motocicletas arriba indicadas, por tanto se utiliza como ejemplo el procedimiento que se debe adoptar en el modelo XDiavel.

Operando en el lado derecho de la motocicleta, aflojar prestando atención a no desatornillar completamente el tornillo (A1) y quitar el grupo contrapeso derecho (A).

Repetir la misma operación para quitar el grupo contrapeso izquierdo (B).

👁 参考

オリジナル部品の取り外し手順は、以下のすべての車両に共通です。

- Diavel
- Monster 659; 797; 821; 1200
- XDiavel
- Supersport

👁 参考

オリジナル部品の取り外し手順は、上記すべての車両に共通です。ここでは例として XDiavel モデルの作業手順を記載していません。

車両の右側で作業します。スクリュー (A1) を完全に取り外さないように注意しながら緩め、右カウンターウェイトユニット (A) を取り外します。

左カウンターウェイトユニット (B) の取り外しについても同様の作業を繰り返します。

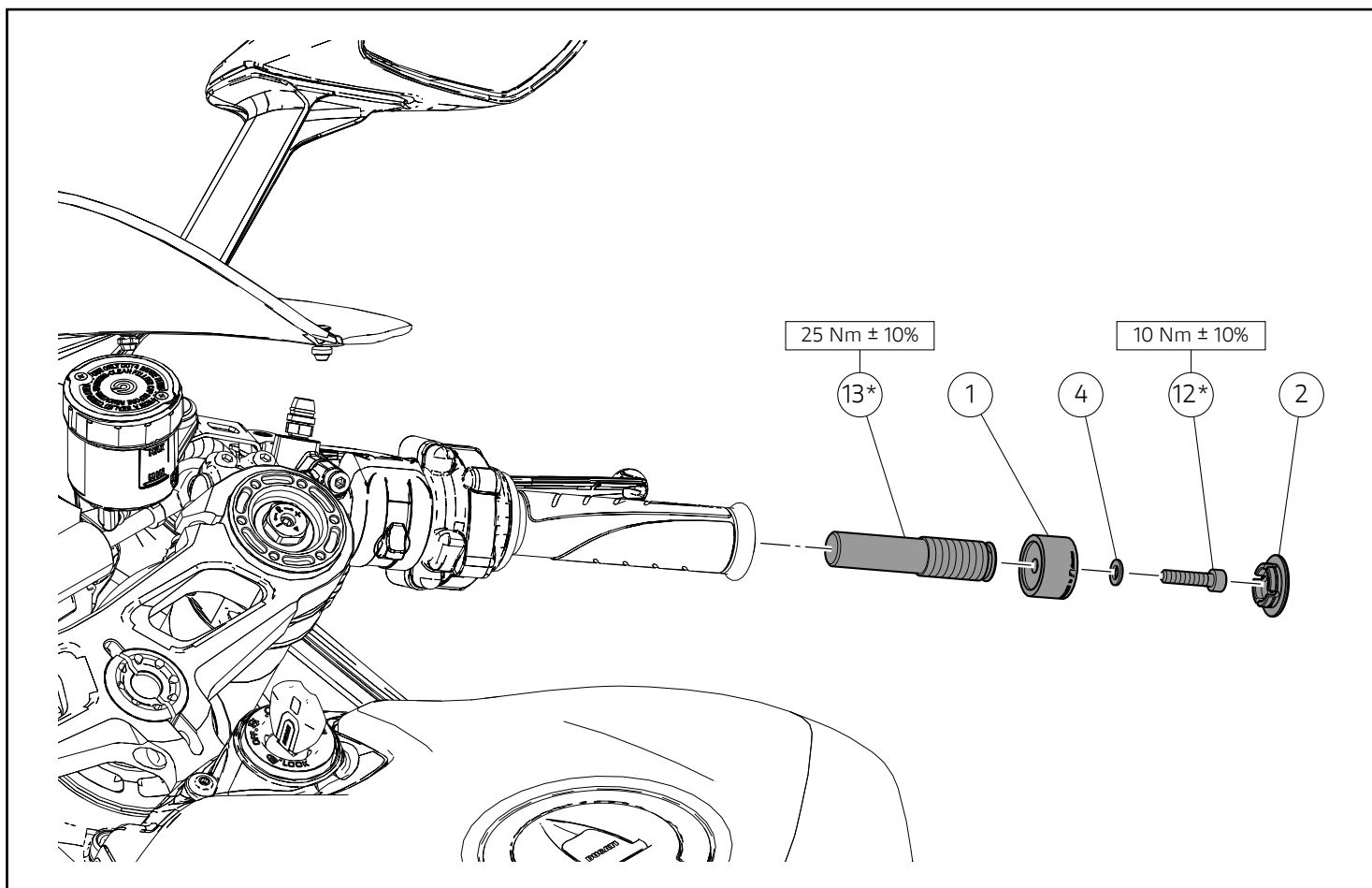

Montaje componentes kit

● Importante

Antes del montaje, comprobar que todos los componentes se encuentren limpios y en perfecto estado. Adoptar todas las precauciones necesarias para evitar dañar cualquier parte en la que se debe operar.

👁️ Notas

El procedimiento de montaje de los componentes del kit es el mismo para todas las motocicletas:

- Panigale 899; 959; 1199; 1299
- Panigale R

👁️ Notas

El procedimiento de montaje de los componentes del kit es el mismo para todas las motocicletas arriba indicadas, por tanto se utiliza como ejemplo el procedimiento que se debe adoptar en el modelo Panigale 1299.

Montaje terminal manillar

Aplicar LOCTITE 222 en la rosca del perno (13*). Introducir y ajustar el perno (13*) en el semimanillar, al par de apriete indicado. Introducir la arandela (4) en la rosca del tornillo (12*). Posicionar el terminal manillar (1) en el semimanillar e introducir el tornillo (12*). Ajustar el tornillo (12*) al par de apriete indicado. Montar el tapón (2) en el terminal manillar (1).

Repetir la misma operación para el montaje terminal manillar en el lado izquierdo de la motocicleta.

キット部品の取り付け

● 重要

取り付けの前に全ての部品に汚れがなく、完璧な状態であることを確認してください。作業する部分が破損しないように、必要なすべての予防措置を講じてください。

👁️ 参考

キット構成部品の取り付け手順は、以下のすべての車両に共通です。

- Panigale 899; 959; 1199; 1299
- Panigale R

👁️ 参考

キット構成部品の取り付け手順は、上記すべての車両に共通です。ここでは例として Panigale 1299 モデルの作業手順を記載しています。

ハンドルバーエンドの取り付け

ピン (13*) のネジ山に LOCTITE 222 を塗布します。ピン (13*) をハンドルバーに差し込み、規定のトルクで締め付けます。ワッシャー (4) をスクリュー (12*) のネジ山に取り付けます。ハンドルバーエンド (1) をハンドルバーに配置し、スクリュー (12*) を差し込みます。スクリュー (12*) を規定のトルクで締め付けます。キャップ (2) をハンドルバーエンド (1) に取り付けます。

車両左側のハンドルバーエンド取り付けについても同様の作業を繰り返します。

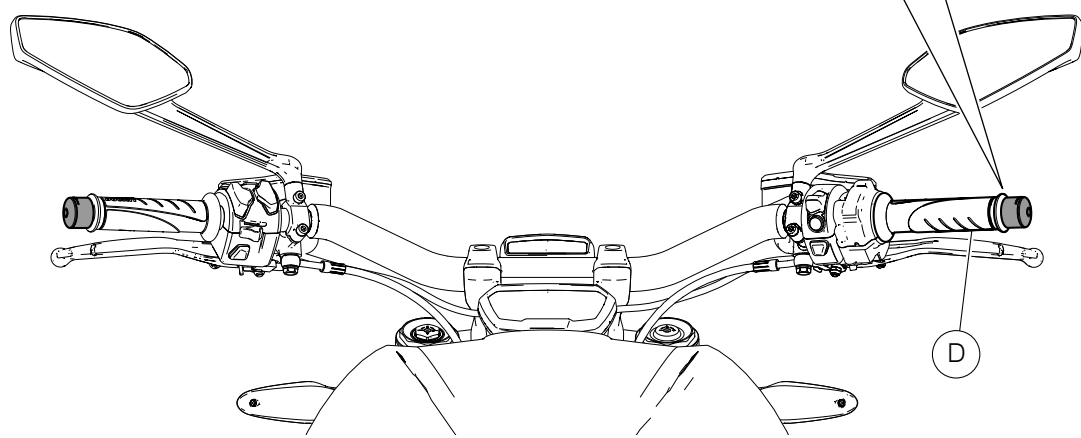
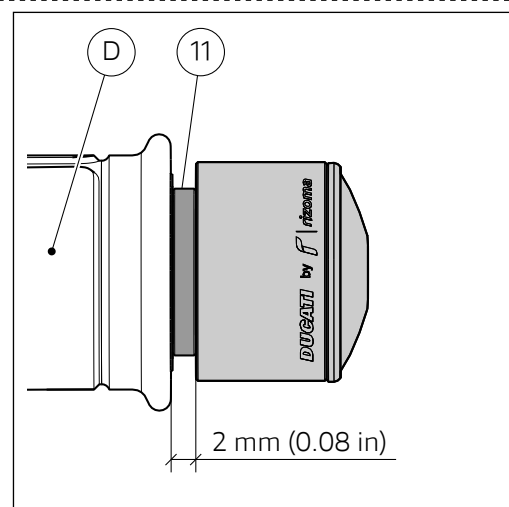
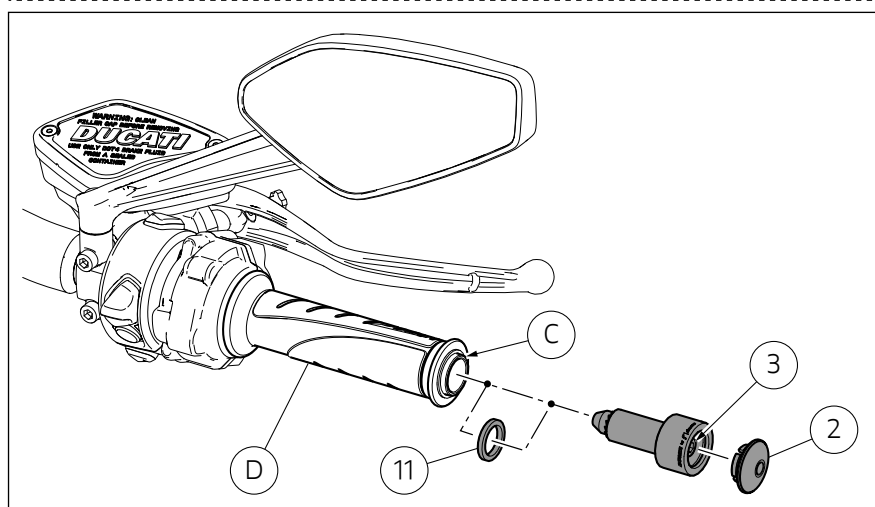
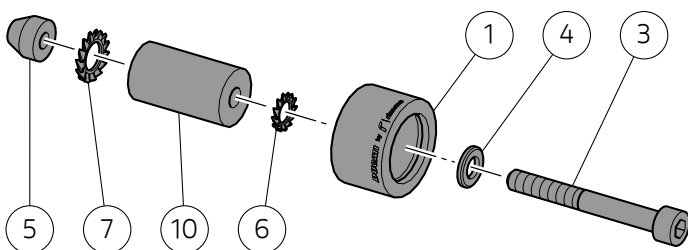
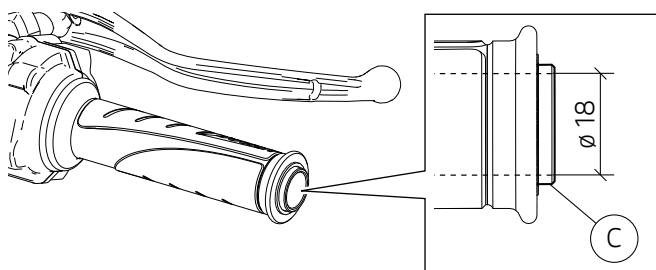
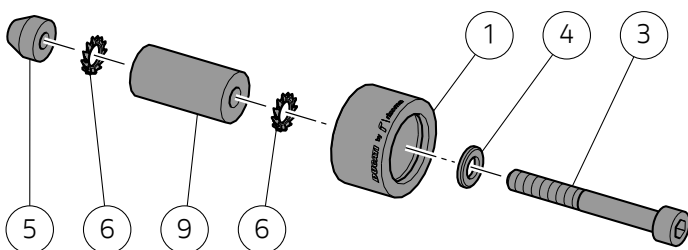
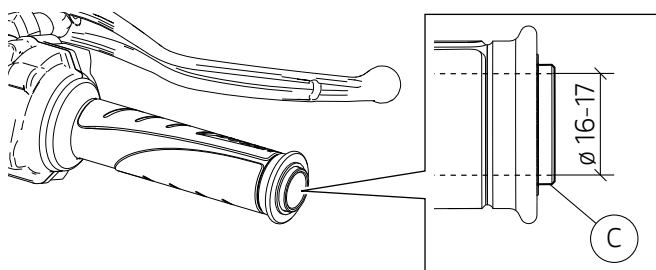
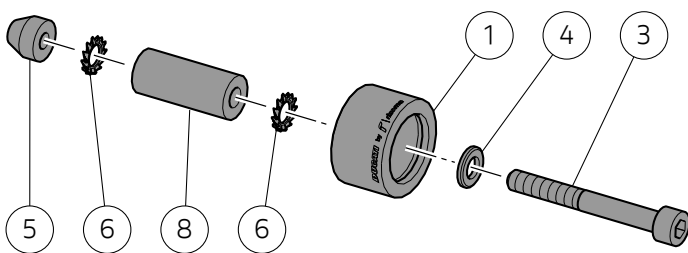
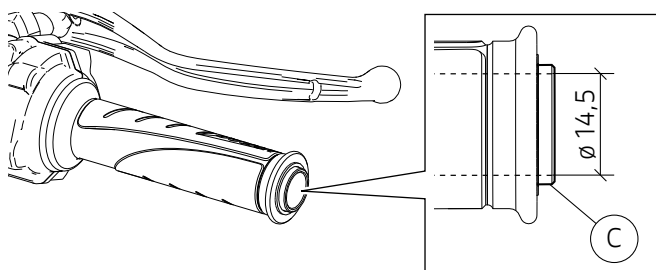



Notas

El procedimiento de montaje de los componentes del kit es el mismo para todas las motocicletas:

- Diavel
- Monster 659; 797; 821; 1200
- XDiavel
- Supersport



Notas

El procedimiento de desmontaje de los componentes originales es el mismo para todas las motocicletas arriba indicadas, por tanto se utiliza como ejemplo el procedimiento que se debe adoptar en el modelo XDiavel.

Premontaje terminal manillar

Introducir la arandela (4) en la rosca del tornillo (3). Introducir el tornillo (3) en el terminal manillar (1). Por el lado opuesto, en la rosca del tornillo (3), introducir la arandela dentada (6).



Importante

Los expansores (8), (9), (10) y las arandelas dentadas (6), (7) se usan como alternativa entre sí, en base al diámetro interior del manillar (C).

Introducir el expansor y la arandela adecuada en la rosca del tornillo (3) y atornillar el casquillo (5).

Montaje terminal manillar

Operando en el lado derecho de la motocicleta, montare el grupo terminal, hasta el tope, en el manillar (C), comprobando que la distancia entre el terminal del mando acelerador (D) y el grupo terminal manillar no sea inferior a 2 mm (0.08 in).



Atención

En caso de que la distancia resulte inferior a los 2 mm (0.08 in), es necesario montar el separador (11).



Atención

Una vez terminado el montaje, comprobar que el mando acelerador (D) gire libremente en toda su carrera.

Ajustar el tornillo (3) hasta bloquear el grupo terminal en el manillar (C). Montar el tapón (2) en el grupo terminal manillar.

Repetir la misma operación para el montaje terminal manillar en el lado izquierdo de la motocicleta.



参考

Kit構成部品の取り付け手順は、以下のすべての車両に共通です。

- Diavel
- Monster 659; 797; 821; 1200
- XDiavel
- Supersport



参考

オリジナル部品の取り外し手順は、上記すべての車両に共通です。ここでは例として XDiavel モデルの作業手順を記載しています。

ハンドルバーエンドの仮取り付け

ワッシャー (4) をスクリュー (3) のネジ山に取り付けます。スクリュー (3) をハンドルバーエンド (1) に取り付けます。反対側から、スクリュー (3) のネジ山に歯付きワッシャー (6) を取り付けます。



重要

エキスパンダー (8)、(9)、(10) と歯付きワッシャー (6)、(7) は、ハンドルバー (C) 内径に応じて取り替えてください。

エキスパンダーと適切なワッシャーをスクリュー (3) のネジ山に挿入し、ブッシュ (5) をねじ込みます。

ハンドルバーエンドの取り付け

車両の右側で作業します。エンドユニットをハンドルバー (C) に奥まで取り付け、スロットルグリップエンド (D) とハンドルバーエンド間の距離が 2 mm (0.08 in) 以上あることを確認してください。



警告

距離が 2 mm (0.08 in) に満たない場合は、スペーサー (11) を取り付けてください。



警告

取り付けが完了したら、スロットルコントロール (D) が全ストロークで自由に回転することを確認します。

エンドユニットがハンドルバー (C) に固定されるまでスクリュー (3) を締め付けます。キャップ (2) をハンドルバーエンドユニットに取り付けます。

車両左側のハンドルバーエンド取り付けについても同様の作業を繰り返します。

レース専用部品 ご注文書

ご注文商品

1	P/N	商品名
2	P/N	商品名
3	P/N	商品名
4	P/N	商品名
5	P/N	商品名

お客様ご記入欄

私は上記レース専用部品を下記車両に装着し、サーキット走行のみに利用し、一般公道には利用しません。

車台番号	ZDM	モデル名
お客様署名		ご注文日

ドウカティ正規ネットワーク店記入欄

お客様に上記レース専用部品を販売し、レース専用部品のご利用方法を説明いたしました。

販売店署名	販売日	年	月	日
-------	-----	---	---	---

販売店様へお願い

- 上記ご記入の上、弊社アフターセールス部までFAXしてください。FAX : 03 - 6692 - 1317
- 取り付け車両 1台に 1枚でご使用ください。